

BÄRO

Retail
Lighting



IC LUMINAIRE SERIES

Ontero
Intara
Pendiri

Fresh, healthy, ecological, energy-efficient – our lifestyles and standards are changing. The range of products on offer is becoming more complex, guidance and trust more important. We are constantly searching for new types of lighting technology and are consistently developing new presentation options. For our customers. And our customers' customers.

Fresh Light *for* Fresh Products.

Ontero Intara Pendiro

- P. 04 **IC luminaire series**
Design at its best
- P. 08 **Ontero IC**
Perfectly shaped lighting tool
- P. 10 **Intara IC**
Flexible fixed point
- P. 12 **Pendiro IC**
Distinctive look
- P. 14 **BÄRO Individual**
Customised design
- P. 16 **IC colour code**
BÄRO light colours and luminous fluxes
- P. 22 **IC lighting technology**
Beam characteristics, light distribution curves and cone diagrams
- P. 39 **IC product overview**
Product numbers: luminaires, drivers, accessories
- P. 42 **Service**
Your lighting partner. Right from the start.
Publishing details



IC0 2
NIC 0
AWA 1
RDS 7

**INTERIOR
INNOVATION**

selection

IC luminaire series

DESIGN AT ITS BEST

The Pendiro IC suspended luminaire was a winner of the “ICONIC AWARDS 2017” in the category “Interior Innovation - Selection”. This was a further reason to continue the timeless design of the luminaire in the form of a series.

The deliberately different shape as a simple cylinder is an expression of design as a core value. The recess reminiscent of a halfpipe is a characteristic feature.

Track-mounted spotlights, semi-recessed and suspended luminaires with an elegant design language, varied light characteristics and excellent lighting qualities offer unlimited design freedom.

UNUSUAL AND ELEGANT

The IC luminaire series is a statement of timeless aesthetics, formal precision and maximum flexibility.

It combines high light and product quality with a special range of LED light colours and the demands on creative lighting concepts that showcase retail and display areas.

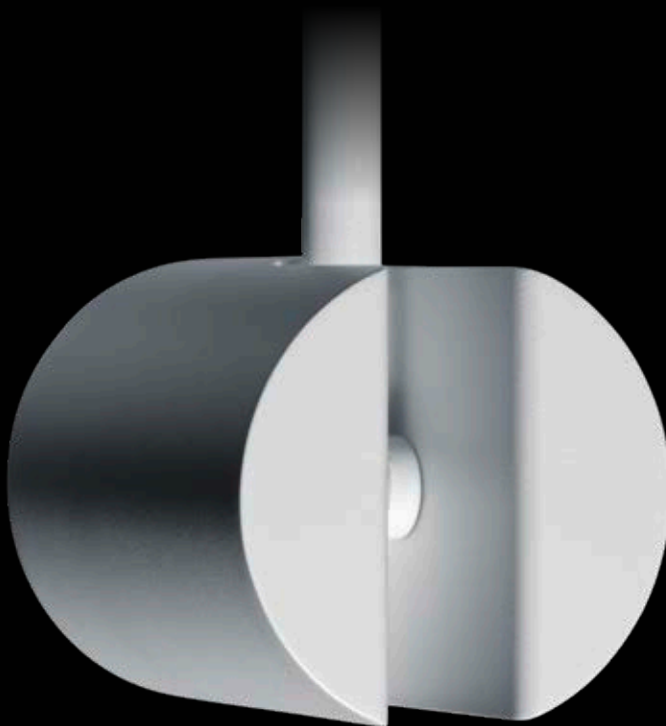

OPTIMAL FOCUS

The position of the joint in the middle of the luminaire head centres the weight of the luminaire below the track.



4 WATTAGES

15 W (400mA) . 23 W (600mA) .
34 W (850mA) . 41 W (1,050mA)

12 LIGHT COLOURS

927 . 830 . 835 . 840 .
PearlWhite . BeColor .
BeCool . BeNature* .
GoldenBread* . Sun* .
SpecialMeat* . Meat&Fish
* exclusive product-specific
special light colours

6 BEAM ANGLES

NarrowSpot 10° . Spot 20° .
Medium 25° . Flood 44° .
OvalBasic 60° x 40° .
WallBeam



EFFICIENCIES

Luminaire luminous fluxes: up to 4,880 lm
Luminous efficacy: up to 147 lm/W

CONTROL

Constant current . DALI (Intara and Pendirol) .
Potentiometer (Intara) . Casambi

INDIVIDUAL

Various colour combinations, RAL and NCS
colours, galvanised surfaces . With metallic
surfaces the usable power is reduced to max. 23W.



Honeycomb louver



OvalBeam lens

ACCESSORIES

Honeycomb louver (for NarrowSpot,
Spot and Medium reflector)
OvalBeam lens (for Spot and Medium
reflector, the luminaire luminous flux
is reduced by approx. 25%)

Ontero IC

PERFECTLY SHAPED LIGHTING TOOL

The new in-track adapter integrates drivers and smart lighting technologies, reducing the design to the lighting head. The dimension of the arm allows the elegant body to come into its own.



INVISIBLE DRIVER TECHNOLOGY

The driver box is hidden in the track as part of the adapter.

SMART-LIGHTING-TECHNOLOGY

A Casambi version is available for wireless lighting control via Bluetooth Low Energy (BLE).



GERMAN
DESIGN
AWARD
WINNER
2020

Ontero IC

Surface-mounted luminaire

COLOUR CODE	927	830	835	840
Luminaire luminous flux [lm]	2,990	3,860	3,900	4,000
System wattage [W]	34	34	34	34
COLOUR SPECTRUM	PearlWhite		BeColor	
Luminaire luminous flux [lm]	3,180		2,700	
System wattage [W]	34		34	
COLOUR SPECTRUM	BeCool		BeNature	
Luminaire luminous flux [lm]	2,770		1,370	
System wattage [W]	34		34	
COLOUR SPECTRUM	GoldenBread		Sun	
Luminaire luminous flux [lm]	3,080		2,010	
System wattage [W]	34		34	
COLOUR SPECTRUM	Meat&Fish		SpecialMeat	
Luminaire luminous flux [lm]	2,070		1,750	
System wattage [W]	34		34	



ONTERO IC WITH MEDIUM REFLECTOR

- Available wattages: 15 W, 23 W, 34 W (41 W from 4th quarter 2019)
- The maximum available system power and the resulting luminaire luminous fluxes for the reflector Medium 25° are stated.
- For metallic surfaces the usable power is reduced to max. 23 W.
- All data are typical values. The luminaire luminous flux figures vary in a tolerance range of ± 10 %.

Surface-mounted luminaire with LEDs, rated lamp lifetime of the LEDs L80/B10 > 50,000h, chromaticity point tolerance 2 SDCM (initial), 3 SDCM (initial) for SpecialMeat, Meat&Fish, GoldenBread, Sun, LED hybrid technology, (reflector-lens combination for NarrowSpot, Spot, Medium, OvalBasic), 3D silicone lens to reduce the proportion of scattered light, reflector 99.99 % pure aluminium in MIRO-Silver®, exchangeable reflector unit in high-shine black plastic, glass cover, luminaire pivoted and adjustable, luminaire head and arm die-cast aluminium, luminaire colour black, silver, white, powder-coated, in-track adapter incl. driver black, white plastic, camera-compatible driver unit, protection rating IP 20, protection class II, weight 1.1 kg

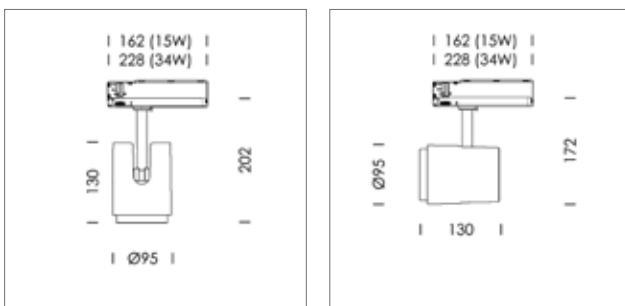

System features may change with product improvements due to technical advances. Further information and light distribution curves can be found from page 22 onwards.

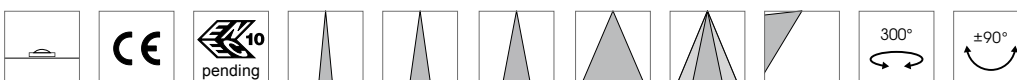

Intara IC

FLEXIBLE FIXED POINT

With its concave ceiling fitting, the Intara IC luminaire is perfectly integrated in the room. Ceiling mounting, connecting arm and luminaire head with a distinctive, award-winning design form a harmonious unit.

All lighting options offered by the IC series can be used for effective, flexible and efficient illumination of surfaces.

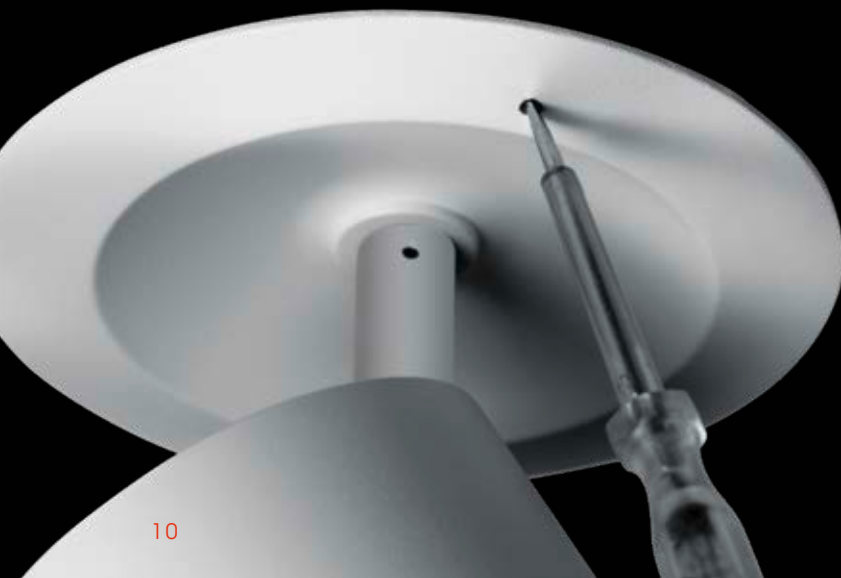

BRIGHTNESS ADJUSTMENT
A potentiometer on the ceiling fitting enables simple dimming of the luminaire.

CUSTOMISABLE
The option of customising the length of the arm opens up further application possibilities.



Pendiro IC

DISTINCTIVE LOOK

Pendiro IC suspended luminaire is a symbiosis of “ambient luminescence” and “play of brilliants”, to use the terms coined by American lighting designer Richard Kelly. The outstanding design is a decorative element that makes its mark on the surroundings. The design surprises, appears light and is the first choice for numerous interior and lighting designers.

FREELY SELECTABLE

Recessed, surface-mounted and track-mounted canopies allow flexible use of the luminaires, regardless of the spatial situation.

DELICATE SUSPENSION CABLE

A characteristic features is the elegant suspension on two insulated live steel cables.

IC 0 2
NIC 0
AWA 1
RDS 7

INTERIOR
INNOVATION

selection

Pendiro IC

Suspended luminaire

COLOUR CODE	927	830	835	840
Luminaire luminous flux [lm]	2,250	2,900	2,930	3,000
System wattage [W]	23	23	23	23
COLOUR SPECTRUM	PearlWhite		BeColor	
Luminaire luminous flux [lm]	2,400		1,990	
System wattage [W]	23		23	
COLOUR SPECTRUM	BeCool		BeNature	
Luminaire luminous flux [lm]	2,050		1,040	
System wattage [W]	23		23	
COLOUR SPECTRUM	GoldenBread		Sun	
Luminaire luminous flux [lm]	2,300		1,520	
System wattage [W]	23		23	
COLOUR SPECTRUM	Meat&Fish		SpecialMeat	
Luminaire luminous flux [lm]	1,560		1,320	
System wattage [W]	23		23	

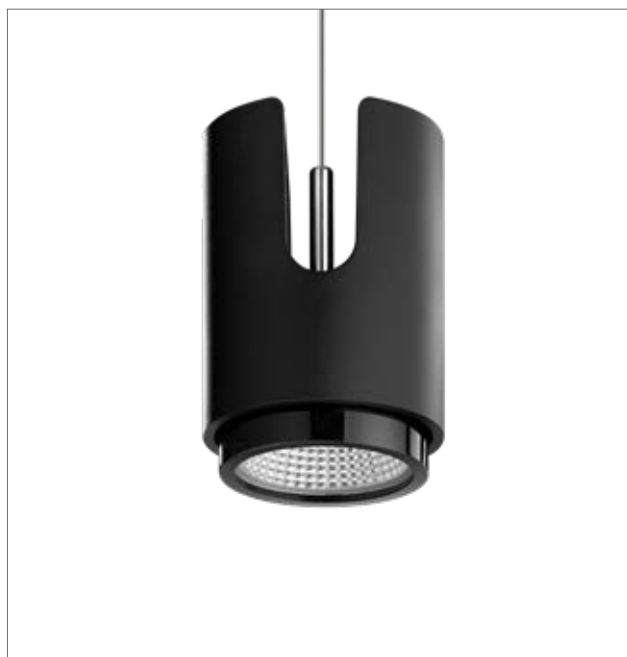

PENDIRO IC WITH MEDIUM REFLECTOR

- Available wattages: 15 W/23 W (On/Off, DALI for recessed, DALI 100% -7% for surface-/track-mounted)
- The maximum available system power and the resulting luminaire luminous fluxes for the reflector Medium 25° are stated.
- All data are typical values. The luminaire luminous flux figures vary in a tolerance range of ± 10 %.

Suspended luminaire with LEDs, rated lamp lifetime of the LEDs L80/B10 > 50,000h, chromaticity point tolerance 2 SDCM (initial), 3 SDCM (initial) for SpecialMeat, Meat&Fish, GoldenBread, Sun, LED hybrid technology, (reflector-lens combination for NarrowSpot, Medium, OvalBasic), 3D silicone lens to reduce the proportion of scattered light, reflector 99.99% pure aluminium in MIRO-Silver®, exchangeable reflector unit in high-shen black plastic, glass cover, luminaire head die-cast aluminium, luminaire colour black, silver, white, powder-coated, attachment variants: surface-mounted canopy, track-mounted canopy (integrated driver unit), recessed canopy (separate driver unit), camera-compatible driver unit, power supply via suspension cables, protection rating IP 20, protection class I / III (depending on attachment variant), weight 2.2 kg

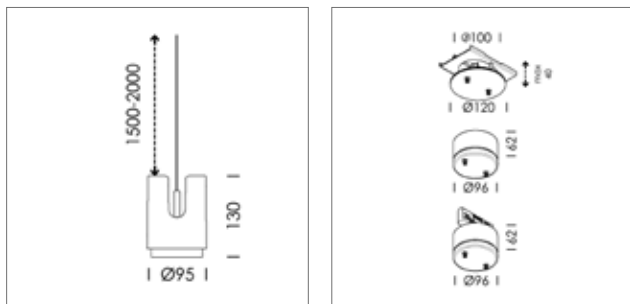

System features may change with product improvements due to technical advances. Further information and light distribution curves can be found from page 22 onwards.



Customised design

BÄRO INDIVIDUAL



With BÄRO Individual any colour from the RAL or NCS range can be selected as a paint finish for our luminaires – an option that is of interest to both brand architects and designers of exclusive and unique interiors.



The design options are expanded even further with metallic surfaces such as chrome, copper or gold. BÄRO luminaires can be adapted to suit individual wishes, architectural styles or surrounding materials. The implementation of a corporate design is also a simple matter.*



Gold
glossy



Copper
glossy



Copper
burnished

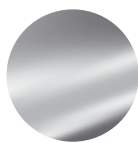

Chrome
glossy



Nickel
matt



Nickel
velour

* For metallic surfaces the usable power is reduced to max. 23 W.



EuroShop 2017
Presentation of different special light colours

We believe that there is a difference between lighting and light. And that light has the power to touch people, to inspire them and to activate them. With this conviction – and decades of experience – we develop unique BÄRO special light colours.

This means that there is not one light for everything. But precisely the right light for every individual requirement – so that every product is shown in the best light.

BÄRO. The Colour *of* Light.

In the right light

SPECIAL LIGHT COLOURS

Light that optimises the natural colours of products is one of the most effective, but also one of the most sophisticated tools of retail lighting. Thanks to decades of experience, BÄRO has the corresponding products, technologies and the necessary expertise.

Light creates an atmosphere – and it supports the sales-promoting presentation of all kinds of products. From fresh food-stuffs to non-food products, fashion and leisure goods – lighting with a coordinated spectral composition can render the colour, material and surface properties of products in a way that showcases them and makes the best possible impression on customers. Successful sales-promoting lighting therefore deliberately engages with expectations and visual habits – and evokes positive associations.

For example, you see a ripe red apple in the fruit display. Its colour impression depends on several factors at this moment: an artificial light source illuminates the apple with white light with a certain spectral composition, which rarely corresponds to the continuous spectrum of sunlight. On the other hand the surface of the apple absorbs part of this light spectrum while reflecting other components of the light. These catch

the eye, where sensory cells measure the blue, green and red components of the light and convey them to the visual centre of the brain: ultimately, a subjective colour impression is created.

As not the whole spectrum, but only three selective colour bands are measured and processed by the brain, the “metamerism” phenomenon occurs: light with a different composition can produce the same colour impression for the viewer – and body colours that looked the same under certain lighting may differ greatly under different light.

For product illumination this means: if artificial light spectrums can be technically influenced, the perception of certain colour shades typical to products can be changed in a surprisingly wide range. Depending on the lighting, the red of the apple can appear warmer or cooler, more or less saturated. The art of product lighting that optimises the products’ own colours is

to use light spectrums tailored to different applications. BÄRO has been a trailblazer in this art for many years.

As far back as 50 years ago BÄRO used PAR lamps with special coatings and later high-pressure discharge lamps with special glass filters holding back defined spectral components for one of the most popular applications for light optimising natural colours: the illumination of fresh meat and cold cuts. This “SpecialMeat” light optimised the red and pink colours of the products so that they were shown to much better advantage than under the simple fluorescent lamps that were standard at that time.

Even this pioneering application shows that lighting that optimises the inherent colours of products is always a balancing act: on the one hand retailers and customers want an inviting product presentation, but on the other hand this must never cross the line into falsifying or masking

OVERVIEW OF THE AVAILABLE LIGHT COLOURS

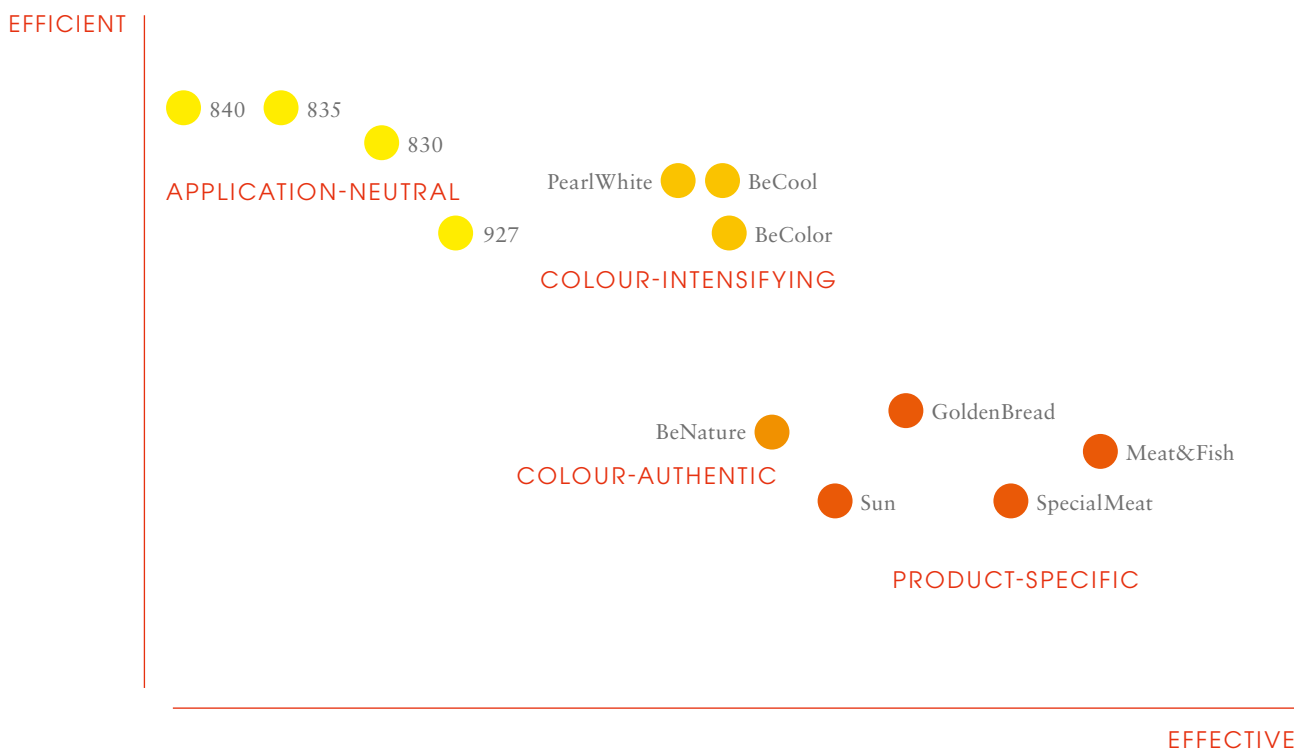

The selection of the right light colour is always a balance between maximum efficiency and optimum product presentation

- Standard light colours with neutral colour rendering
- Special light colours with higher colour saturation (for EC only PearlWhite)
- Special light colours with a colour authentic spectrum
- Special light colours with an application-specific colour spectrum

Do not hesitate to contact BÄRO and take advantage of the company's expertise and experience if you would like to use light with a product-specific lighting effect in your projects as a retailer, retail designer or lighting planner. Our experts will be pleased to advise you – from the design to detailed planning, installation and alignment of the luminaires.

“LED technology offers numerous starting points for defining light spectrums.”

the products – a question of sensitivity and experience which BÄRO has acquired over many years.

Lamps and filters are now largely a thing of the past – BÄRO now exclusively develops LED luminaires and also has methods for using this technology to produce light spectrums that optimise the natural colours of products. The prerequisites for this are good, as LED technology offers numerous starting points for defining light spectrums. Standard white LEDs always initially produce blue light that is partly converted into other wavelengths through a phosphor coating. The mix creates white light. The choice of semi-conductor materials, the composition of the phosphors and, if applicable, the combination with coloured LEDs result in customised spectrums.

BÄRO works closely with technology partners to offer its customers an extensive range of standard and special light colours tailored to individual needs. At BÄRO, the standard light colours are the white tones

that are oriented to the “Planck curve” and are described with standard specification of the light colour number or the colour temperature in Kelvin. Here BÄRO already offers a wider range than usual, from warm white (2,700 K) to 3,000 K and 3,500 K and neutral white (4,000 K). Customers can choose between excellent colour rendering quality with $R(a) > 90$ or slightly higher luminous efficacy yet still with good colour rendering quality $R(a) > 80$ as a particularly efficient solution in non-critical applications.

In addition to these standard light colours there are special light colours: LED modules where the spectrums and chromaticity points are not oriented to the Planck curve. They cannot be defined with standard specification of the colour temperature and colour rendering index, but rather by their respective practical

application. In addition to well-proven classics such as “SpecialMeat” for meat and cold cuts and “Sun” for fruit and vegetables, BÄRO is constantly researching new special light colours that take account of current technologies and market needs.

The light spectrum

Visible light is the small portion of electromagnetic radiation that the human eye is able to see without technical aids.

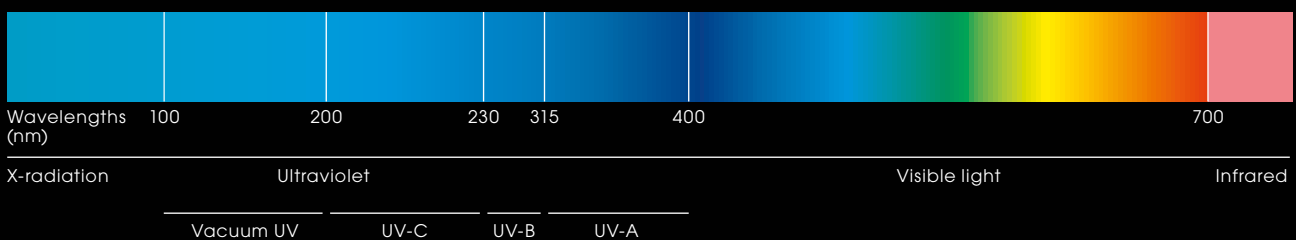

OVERVIEW OF LUMINAIRE LUMINOUS FLUXES

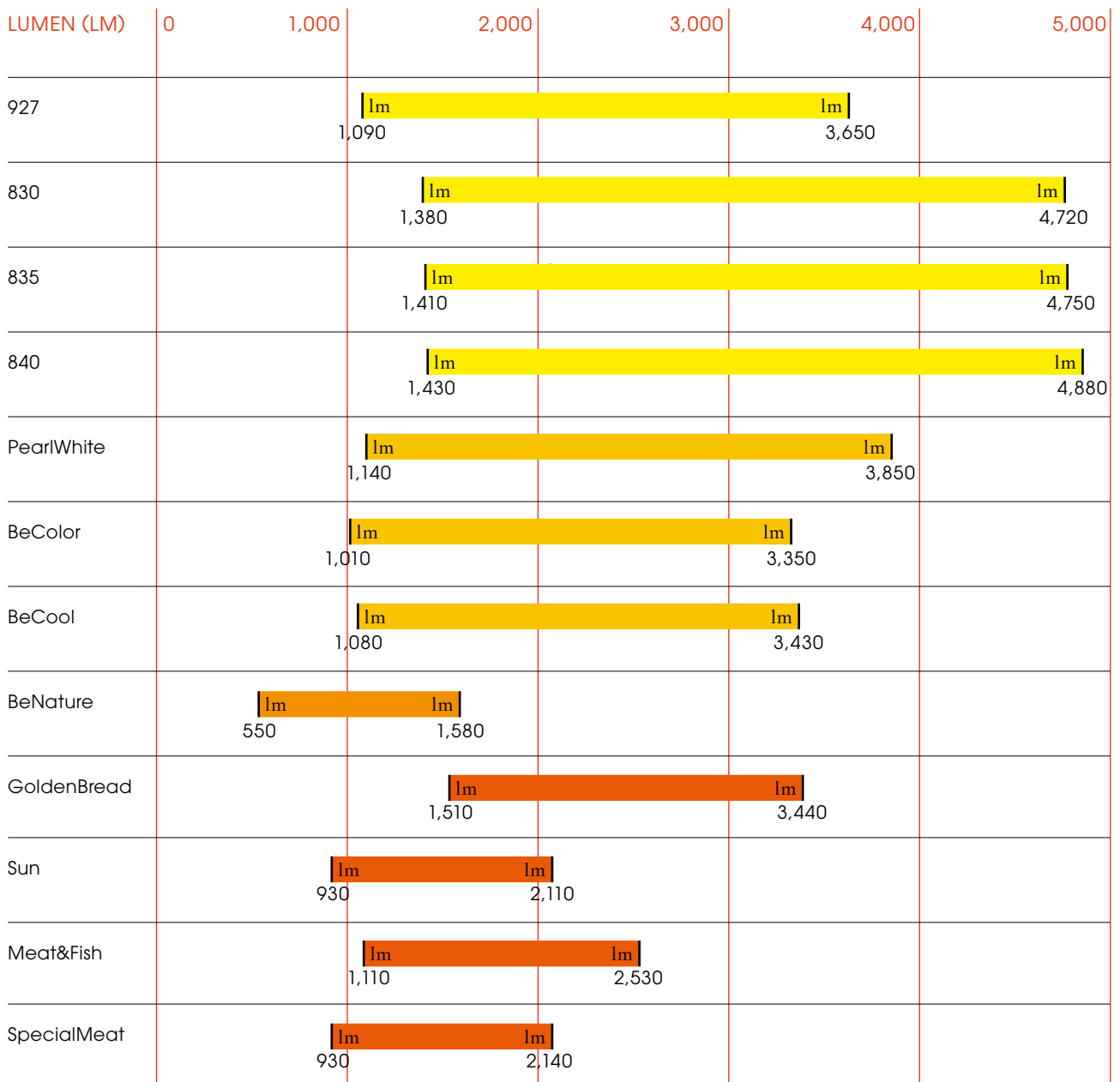

When used with an OvalBeam lens, the luminaire luminous flux is reduced by approx. 25%.

IC lighting technology

UNPARALLELED QUALITY



Highly efficient LED hybrid optics from BÄRO combine the advantages of reflectors and lens systems and produce a particularly balanced contrast between the focal point and the corona of the light cone.

LED hybrid technology with a special 3D silicone lens on the LED module ensures that less light is directly emitted and more light reaches the target surface in a controlled manner via the reflector facets. The innovative silicone lens material combines excellent optical properties with high durability and precision.

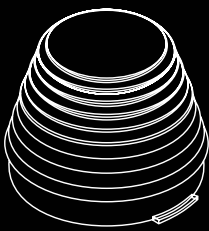

ADVANTAGES OF THE BÄRO SILICONE LENS:

- Form retaining and temperature resistant > 150°
- Resistant to ageing in visible and UV light
- Very high transmittance over the whole visible spectrum
- Extremely high optical quality thanks to precisely moulded structures
- Flexible and therefore particularly mechanically robust

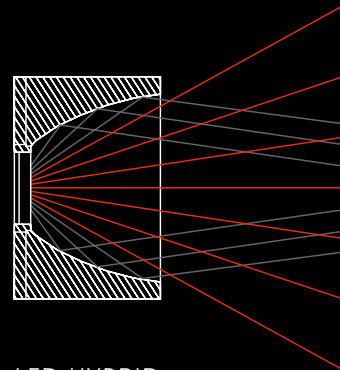
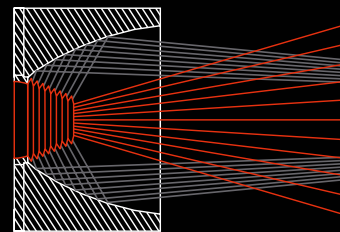

LED HYBRID TECHNOLOGY
Comparison of light cone with (top) and without (bottom) silicone lens

Beam characteristics

Example of the how the beam angle and the illuminance change.

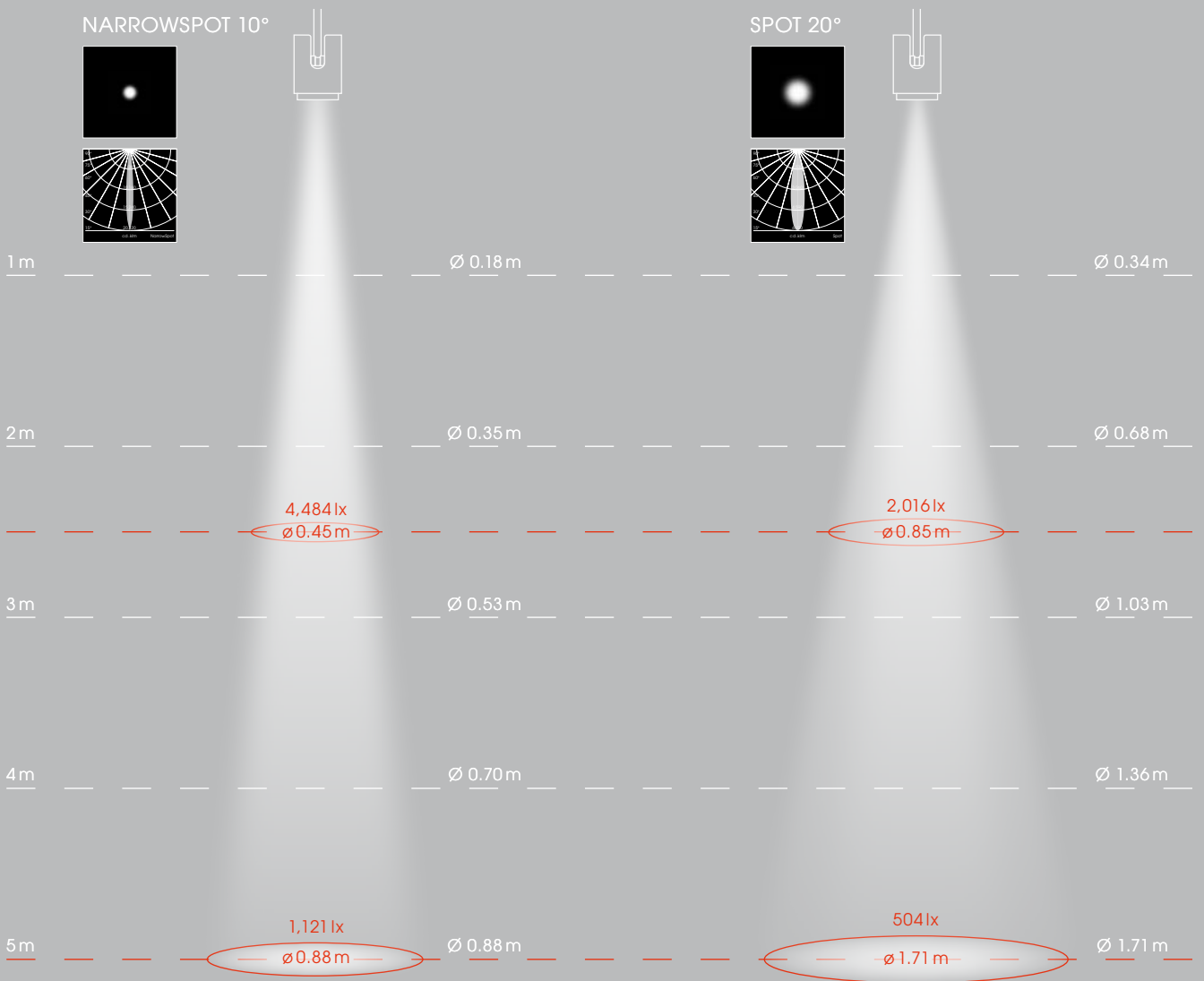

The beam angle defines the diameter of the light cone.

A narrow, symmetrical beam angle (10°) bundles the light so strongly that surfaces are brightly illuminated, even from greater distances.

With a rotation-symmetrical reflector the diameter of the light cone increases proportionally with the distance, while the illuminance decreases with the square of the distance.

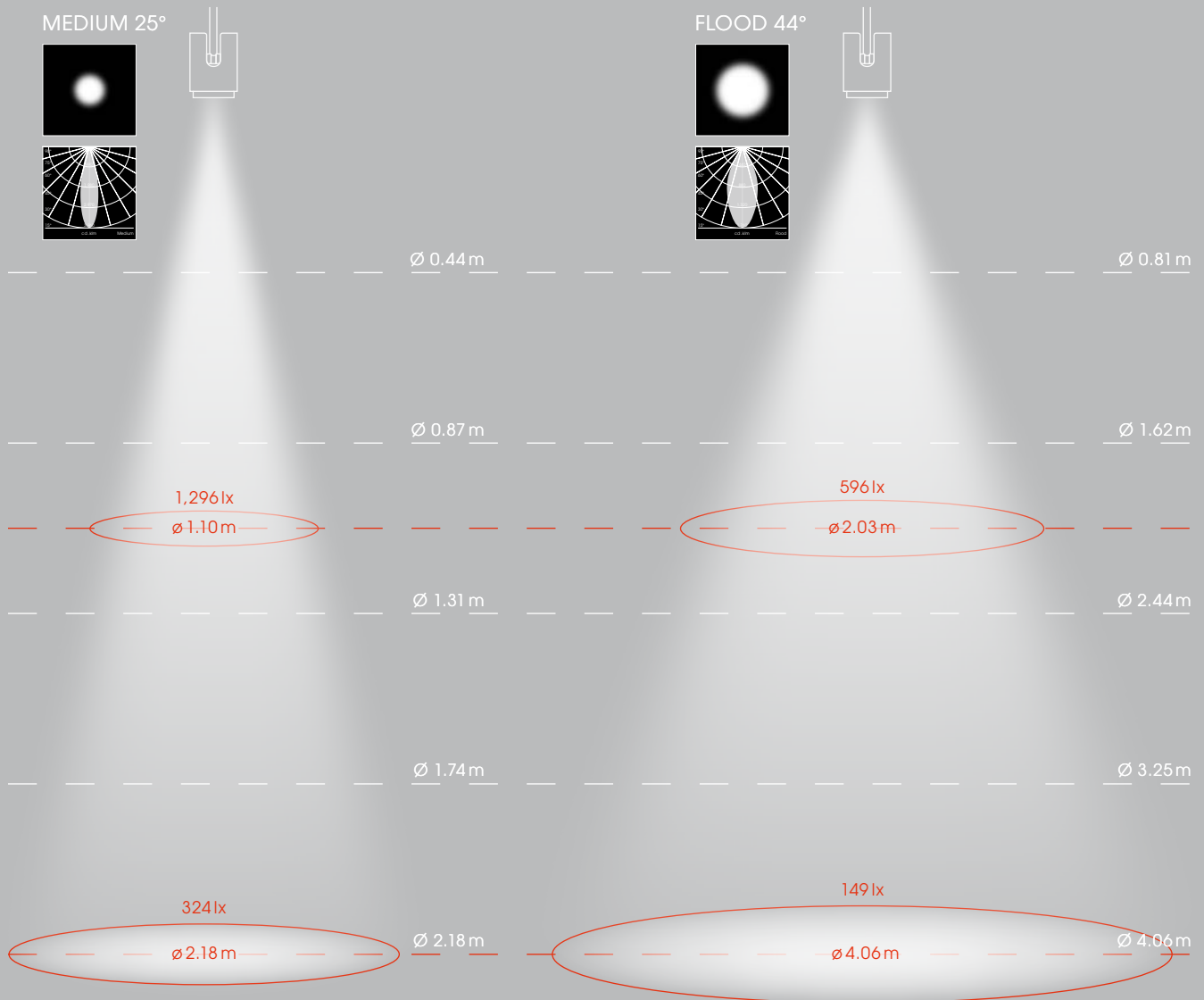

The wider the beam angles are (20°, 25°, 44°), the greater the illuminated surface, but with decreasing illuminance.

The values given in the examples apply to Intara IC, 830, 15W.

Special light distribution

Examples of horizontal and vertical light channelling

OVALBASIC REFLECTOR

OvalBasic reflectors are ideal for homogeneous illumination of long product displays from a normal room height with simultaneous illumination of vertical surfaces. With regular arrangement and rotated by 90°, in addition to illuminating narrow elements they can also be used for the even illumination of wall surfaces.

40° × 60°

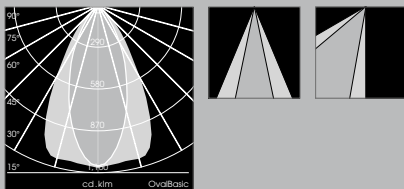

60° × 40°

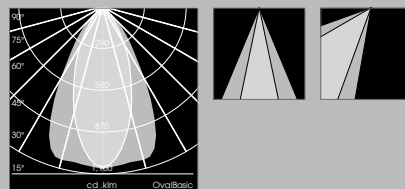

Number of luminaires	5
Distance to illuminated surface [m]	1.00
Distance between luminaires [m]	1.25
Mounting height [m]	3.00

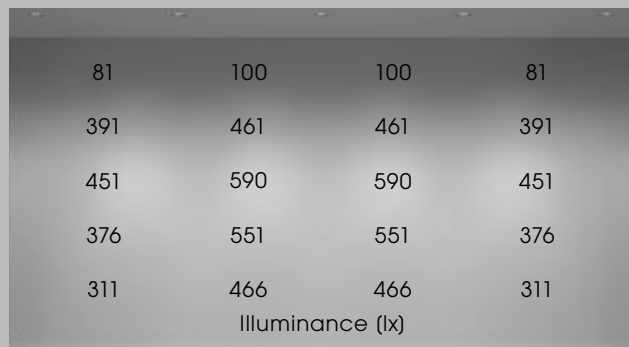

835 . 34W . 3,900lm . 115lm/W

The example shows the light distribution and illuminances on the wall when the reflector is aligned horizontally and the luminaire is pivoted by 15°.

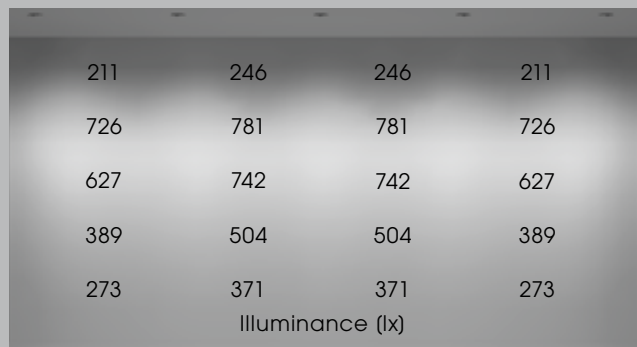

835 . 34W . 3,900lm . 115lm/W

The example shows the light distribution and illuminances on the wall when the reflector is aligned vertically and the luminaire is pivoted by 15°.

The luminaire luminous flux figures vary in a tolerance range of ±10%. Please refer to our data sheets at ww.baero.com, for further technical details on the individual products. All data are typical values. System features may change with product improvements due to technical advances. Errors excepted.

WALLBEAM REFLECTOR

WallBeam reflectors are characterised by their asymmetrical light distribution pattern with a focal point in the centre. Their special beam characteristics make them ideal for the broad and yet powerful and accentuated illumination of room dividing elements with motifs, objects etc. in front of them.

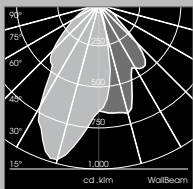

COLOUR CODE

	927	830	835	840
System wattage [W] 15	1,620	2,090	2,110	2,160
23	2,290	2,960	2,990	3,060
34	3,050	3,940	3,570	4,070
41	3,590	4,640	4,680	4,800

Luminaire luminous flux (lm)

Number of luminaires	5
Distance to illuminated surface [m]	1.00
Distance between luminaires [m]	1.25
Mounting height [m]	3.00

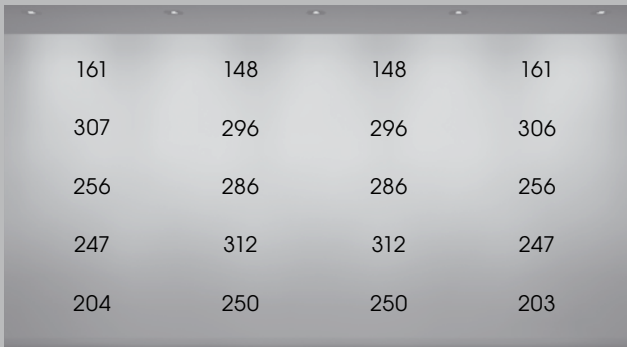

835 . 15W . 2,110lm . 141 lm /W

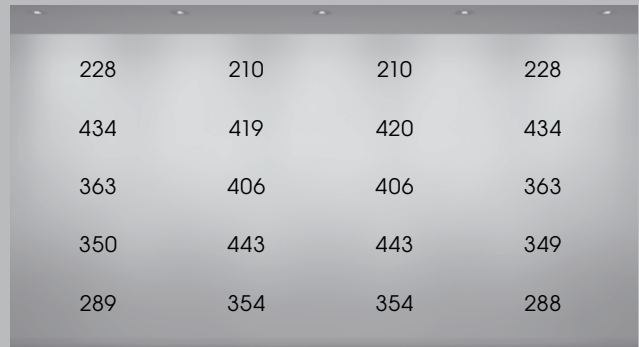

835 . 23W . 2,990lm . 130 lm /W

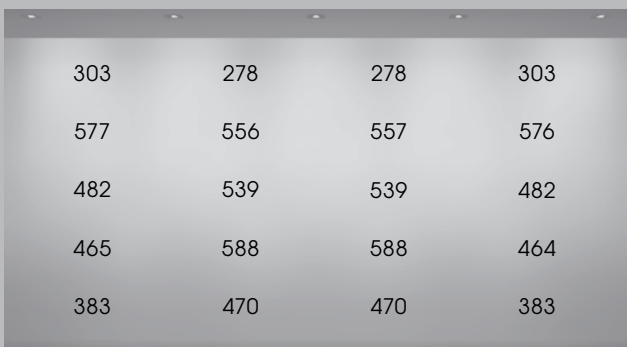

835 . 34W . 3,970lm . 117 lm /W

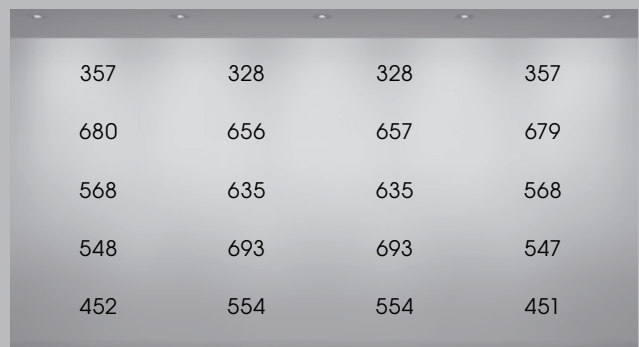

835 . 41W . 4,680lm . 114 lm /W

The luminaire luminous flux figures vary in a tolerance range of ±10%. Please refer to our data sheets at ww.baero.com. for further technical details on the individual products. All data are typical values. System features may change with product improvements due to technical advances. Errors excepted.

927

Colour code

The warm white LED spectrum of the standard light colour is ideal for illuminating goods and product types with warm colours and for creating a harmonious atmosphere. The very good colour rendering gives the surfaces a high-quality appearance and even the smallest colour nuances are clearly apparent.

REFLECTORS

WATTAGES

15W 23W 34W 41W

NARROWSPOT

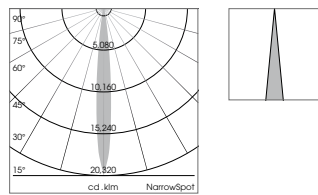

Luminaire luminous flux [lm]
Luminous efficacy [lm/W]

1,090 - - -
73 - - -

Illuminance [lx]

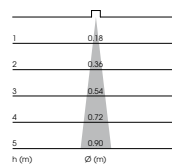

22,136 - - -
5,534 - - -
2,460 - - -
1,383 - - -
885 - - -

SPOT

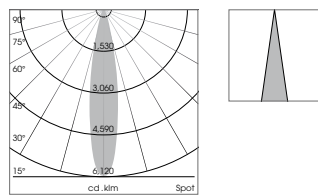

Luminaire luminous flux [lm]
Luminous efficacy [lm/W]

1,600 2,270 3,020 3,560
107 99 89 87

Illuminance [lx]

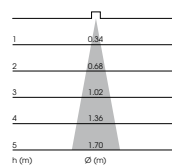

9,735 13,812 18,376 21,661
2,434 3,453 4,594 5,415
1,082 1,535 2,042 2,407
608 863 1,148 1,354
389 552 735 866

MEDIUM

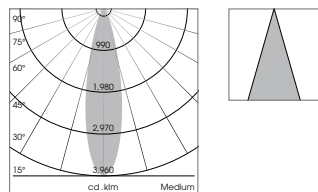

Luminaire luminous flux [lm]
Luminous efficacy [lm/W]

1,590 2,250 2,990 3,530
106 98 88 86

Illuminance [lx]

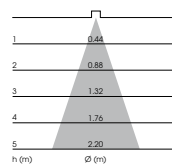

6,290 8,901 11,829 13,965
1,573 2,225 2,957 3,491
699 989 1,314 1,552
393 556 739 873
252 356 473 559

FLOOD

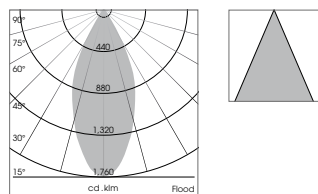

Luminaire luminous flux [lm]
Luminous efficacy [lm/W]

1,640 2,330 3,100 3,650
109 101 91 89

Illuminance [lx]

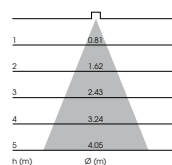

2,886 4,100 5,455 6,423
721 1,025 1,364 1,606
321 456 606 714
180 256 341 401
115 164 218 257

OVALBASIC

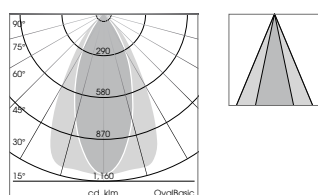

Luminaire luminous flux [lm]
Luminous efficacy [lm/W]

1,590 2,250 2,990 3,530
106 98 88 86

Illuminance [lx]

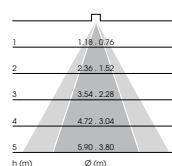

1,795 2,540 3,375 3,984
449 635 844 996
199 282 375 443
112 159 211 249
72 102 135 159

For more technical details about the individual luminaires, please see our datasheets available at www.baero.com. The luminaire luminous flux figures vary in a tolerance range of $\pm 10\%$. All data are typical values. System features may change if product improvements are made due to technical advances. Errors excepted.

830

Colour code

The warm white LED spectrum of the standard light colour is primarily used for efficient lighting when consistent good colour rendering of the colours is desired for all objects being illuminated.

REFLECTORS

WATTAGES

15W 23W 34W 41W

NARROWSPOT

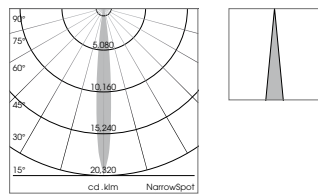

Luminaire luminous flux [lm]
Luminous efficacy [lm/W]

1,380 - - -
92 - - -

Illuminance [lx]

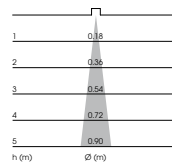

Illuminance [lx]	15W	23W	34W	41W
1	28,025	-	-	-
2	7,006	-	-	-
3	3,114	-	-	-
4	1,752	-	-	-
5	1,121	-	-	-

SPOT

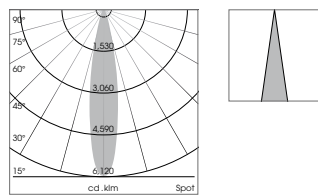

Luminaire luminous flux [lm]
Luminous efficacy [lm/W]

2,070 2,930 3,900 4,600
138 127 115 112

Illuminance [lx]

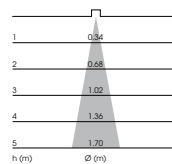

Illuminance [lx]	15W	23W	34W	41W
1	12,595	17,828	23,730	27,989
2	3,149	4,457	5,932	6,997
3	1,399	1,981	2,637	3,110
4	787	1,114	1,483	1,749
5	504	713	949	1,120

MEDIUM

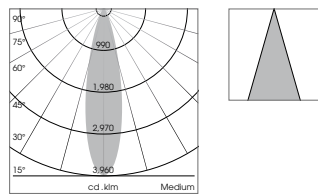

Luminaire luminous flux [lm]
Luminous efficacy [lm/W]

2,050 2,900 3,860 4,550
137 126 114 111

Illuminance [lx]

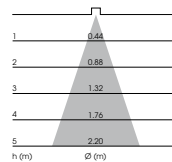

Illuminance [lx]	15W	23W	34W	41W
1	8,110	11,473	15,271	18,001
2	2,028	2,868	3,818	4,500
3	901	1,275	1,697	2,000
4	507	717	954	1,125
5	324	459	611	720

FLOOD

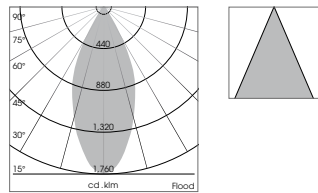

Luminaire luminous flux [lm]
Luminous efficacy [lm/W]

2,120 3,010 4,000 4,720
141 131 118 115

Illuminance [lx]

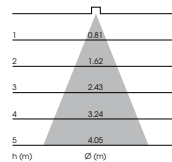

Illuminance [lx]	15W	23W	34W	41W
1	3,730	5,296	7,038	8,305
2	933	1,324	1,760	2,076
3	414	588	782	923
4	233	331	440	519
5	149	212	282	332

OVALBASIC

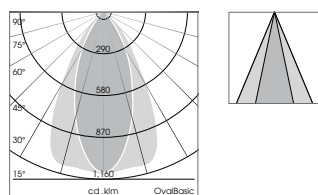

Luminaire luminous flux [lm]
Luminous efficacy [lm/W]

2,050 2,900 3,860 4,550
137 126 114 111

Illuminance [lx]

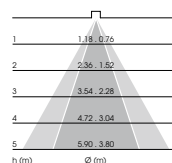

Illuminance [lx]	15W	23W	34W	41W
1	2,314	3,273	4,357	5,136
2	578	818	1,089	1,284
3	257	364	484	571
4	145	205	272	321
5	93	131	174	205

For more technical details about the individual luminaires, please see our datasheets available at www.baero.com. The luminaire luminous flux figures vary in a tolerance range of ± 10%. All data are typical values. System features may change if product improvements are made due to technical advances. Errors excepted.

835

Colour code

The LED spectrum of the standard light colour is between neutral white and warm white and is suitable for use wherever the aim is to efficiently showcase products with an emphasis on their fresh colours or to create a corresponding spatial atmosphere.

REFLECTORS

WATTAGES

15W 23W 34W 41W

NARROWSPOT

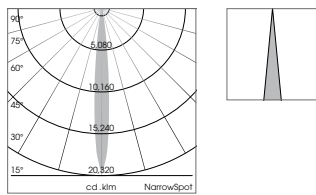

Luminaire luminous flux [lm]
Luminous efficacy [lm/W]

1,410 - - -
94 - - -

Illuminance [lx]

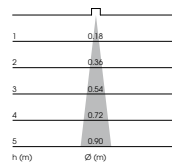

28,634 - - -
7,159 - - -
3,182 - - -
1,790 - - -
1,145 - - -

SPOT

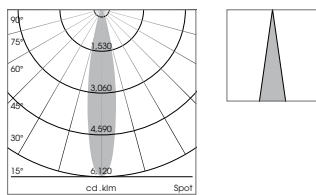

Luminaire luminous flux [lm]
Luminous efficacy [lm/W]

2,100 2,960 3,940 4,640
140 129 116 113

Illuminance [lx]

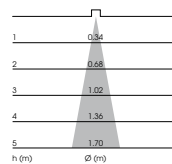

12,778 18,010 23,973 28,233
3,194 4,503 5,993 7,058
1,420 2,001 2,664 3,137
799 1,126 1,498 1,765
511 720 959 1,129

MEDIUM

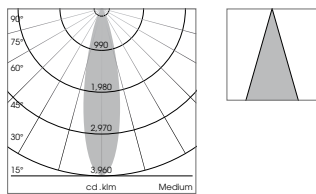

Luminaire luminous flux [lm]
Luminous efficacy [lm/W]

2,070 2,930 3,900 4,590
138 127 115 112

Illuminance [lx]

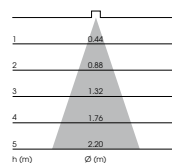

8,189 11,592 15,429 18,159
2,047 2,898 3,857 4,540
910 1,288 1,714 2,018
512 724 964 1,135
328 464 617 726

FLOOD

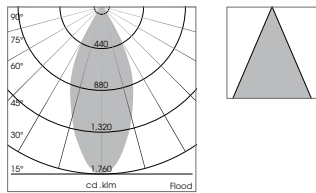

Luminaire luminous flux [lm]
Luminous efficacy [lm/W]

2,150 3,040 4,040 4,750
143 132 119 116

Illuminance [lx]

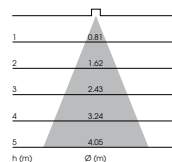

3,783 5,349 7,109 8,358
946 1,337 1,777 2,090
420 594 790 929
236 334 444 522
151 214 284 334

OVALBASIC

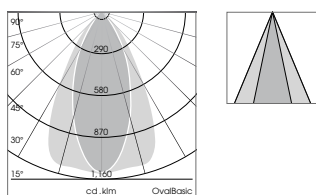

Luminaire luminous flux [lm]
Luminous efficacy [lm/W]

2,070 2,930 3,900 4,590
138 127 115 112

Illuminance [lx]

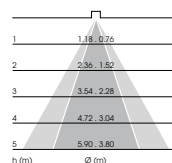

2,336 3,307 4,402 5,181
584 827 1,101 1,295
260 367 489 576
146 207 275 324
93 132 176 207

For more technical details about the individual luminaires, please see our datasheets available at www.baero.com. The luminaire luminous flux figures vary in a tolerance range of $\pm 10\%$. All data are typical values. System features may change if product improvements are made due to technical advances. Errors excepted.

840

Colour code

As a standard light colour, the neutral white LED spectrum is suitable for the efficient illumination of clear body colours or to create a cooler spatial impression.

REFLECTORS

WATTAGES

15W 23W 34W 41W

NARROWSPOT

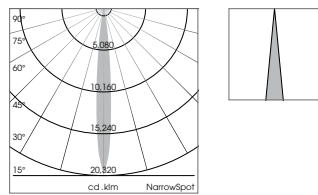

Luminaire luminous flux [lm]
Luminous efficacy [lm/W]

1,430 - - -
95 - - -

Illuminance [lx]

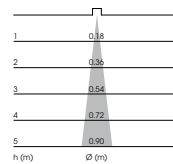

29,040 - - -
7,260 - - -
3,227 - - -
1,815 - - -
1,162 - - -

SPOT

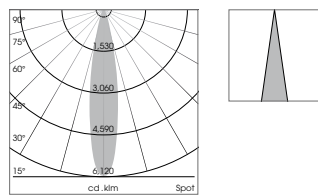

Luminaire luminous flux [lm]
Luminous efficacy [lm/W]

2,140 3,040 4,040 4,760
143 132 119 116

Illuminance [lx]

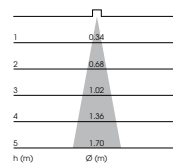

13,021 18,497 24,582 28,963
3,255 4,624 6,145 7,241
1,447 2,055 2,731 3,218
814 1,156 1,536 1,810
521 740 983 1,159

MEDIUM

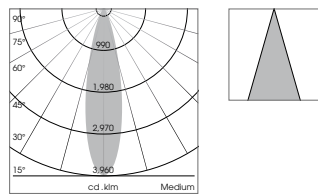

Luminaire luminous flux [lm]
Luminous efficacy [lm/W]

2,120 3,000 4,000 4,710
141 130 118 115

Illuminance [lx]

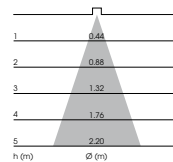

8,387 11,869 15,825 18,634
2,097 2,967 3,956 4,658
932 1,319 1,758 2,070
524 742 989 1,165
335 475 633 745

FLOOD

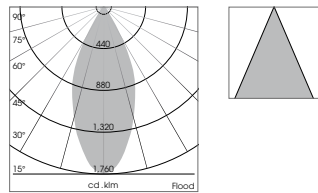

Luminaire luminous flux [lm]
Luminous efficacy [lm/W]

2,200 3,110 4,140 4,880
147 135 122 119

Illuminance [lx]

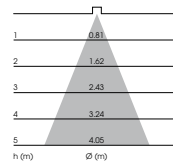

3,871 5,472 7,285 8,587
968 1,368 1,821 2,147
430 608 809 954
242 342 455 537
155 219 291 343

OVALBASIC

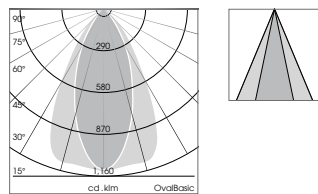

Luminaire luminous flux [lm]
Luminous efficacy [lm/W]

2,120 3,000 4,000 4,710
141 130 118 115

Illuminance [lx]

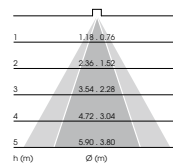

2,393 3,386 4,515 5,316
598 847 1,129 1,329
266 376 502 591
150 212 282 332
96 135 181 213

For more technical details about the individual luminaires, please see our datasheets available at www.baero.com. The luminaire luminous flux figures vary in a tolerance range of ± 10%. All data are typical values. System features may change if product improvements are made due to technical advances. Errors excepted.

PearlWhite

Colour spectrum

The LED spectrum of the special light colour is below the Planck curve (below black body). It has a colour-intensifying effect and creates an elegant atmosphere in the room. The correlated colour temperature is 3,100 K.

REFLECTORS

WATTAGES

15W 23W 34W 41W

NARROWSPOT

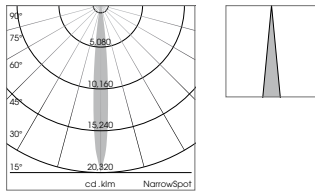

Luminaire luminous flux [lm]
Luminous efficacy [lm/W]

1,140 - - -
76 - - -

Illuminance [lx]

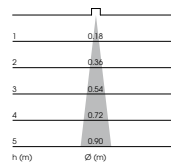

23,151 - - -
5,788 - - -
2,572 - - -
1,447 - - -
926 - - -

SPOT

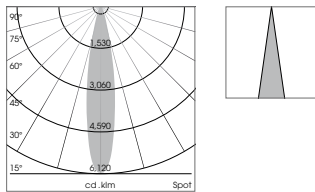

Luminaire luminous flux [lm]
Luminous efficacy [lm/W]

1,710 2,430 3,210 3,760
114 106 94 92

Illuminance [lx]

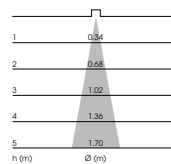

10,405 14,786 19,532 22,878
2,601 3,696 4,883 5,720
1,156 1,643 2,170 2,542
650 924 1,221 1,430
416 591 781 915

MEDIUM

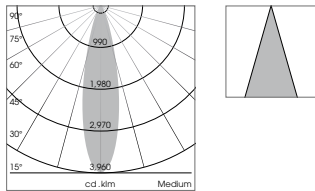

Luminaire luminous flux [lm]
Luminous efficacy [lm/W]

1,690 2,400 3,180 3,720
113 104 94 91

Illuminance [lx]

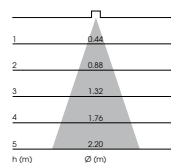

6,686 9,495 12,581 14,717
1,671 2,374 3,145 3,679
743 1,055 1,398 1,635
418 593 786 920
267 380 503 589

FLOOD

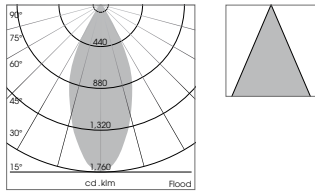

Luminaire luminous flux [lm]
Luminous efficacy [lm/W]

1,760 2,490 3,290 3,850
117 108 97 94

Illuminance [lx]

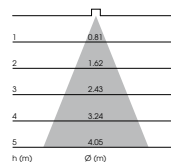

3,097 4,381 5,789 6,774
774 1,095 1,447 1,694
344 487 643 753
194 274 362 423
124 175 232 271

OVALBASIC

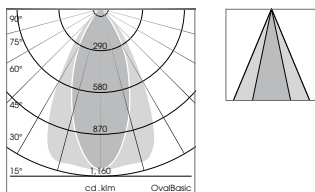

Luminaire luminous flux [lm]
Luminous efficacy [lm/W]

1,690 2,400 3,180 3,720
113 104 94 91

Illuminance [lx]

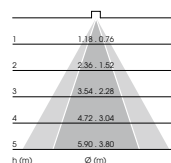

1,908 2,709 3,589 4,199
477 677 897 1,050
212 301 399 467
119 169 224 262
76 108 144 168

For more technical details about the individual luminaires, please see our datasheets available at www.baero.com. The luminaire luminous flux figures vary in a tolerance range of $\pm 10\%$. All data are typical values. System features may change if product improvements are made due to technical advances. Errors excepted.

BeColor

Colour spectrum

The colour-intensifying LED spectrum of the special light colour is below the Planck curve (below black body). The surfaces appear both rich and brilliant. The correlated colour temperature is 3,500 K.

REFLECTORS

WATTAGES

15W 23W 34W 41W

NARROWSPOT

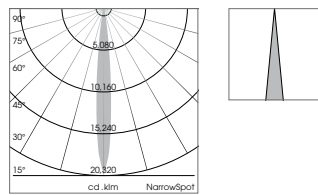

Luminaire luminous flux [lm]
Luminous efficacy [lm/W]

1,010 - - -
67 - - -

Illuminance [lx]

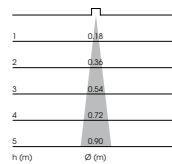

1	0.18	20,511	-	-	-
2	0.36	5,128	-	-	-
3	0.54	2,279	-	-	-
4	0.72	1,282	-	-	-
5	0.90	820	-	-	-

SPOT

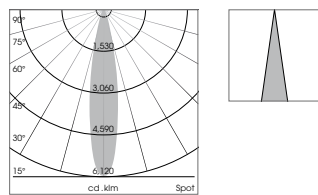

Luminaire luminous flux [lm]
Luminous efficacy [lm/W]

1,400 2,010 2,730 3,270
93 87 80 80

Illuminance [lx]

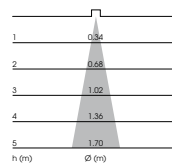

1	0.34	8,518	12,230	16,611	19,897
2	0.68	2,130	3,058	4,153	4,974
3	1.02	946	1,359	1,846	2,211
4	1.36	532	764	1,038	1,244
5	1.70	341	489	664	796

MEDIUM

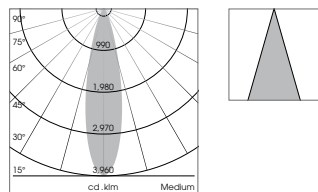

Luminaire luminous flux [lm]
Luminous efficacy [lm/W]

1,380 1,990 2,700 3,230
92 87 79 79

Illuminance [lx]

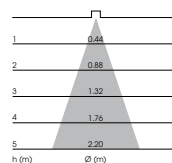

1	0.64	5,460	7,873	10,682	12,779
2	0.88	1,365	1,968	2,670	3,195
3	1.32	607	875	1,187	1,420
4	1.76	341	492	668	799
5	2.20	218	315	427	511

FLOOD

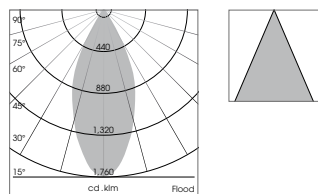

Luminaire luminous flux [lm]
Luminous efficacy [lm/W]

1,430 2,060 2,800 3,350
95 90 82 82

Illuminance [lx]

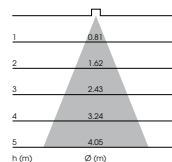

1	0.81	2,516	3,625	4,927	5,895
2	1.22	629	906	1,232	1,474
3	2.43	280	403	547	655
4	3.24	157	227	308	368
5	4.05	101	145	197	236

OVALBASIC

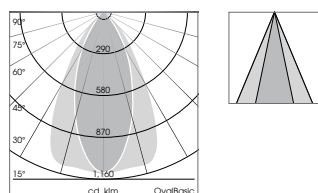

Luminaire luminous flux [lm]
Luminous efficacy [lm/W]

1,380 1,990 2,700 3,230
92 87 79 79

Illuminance [lx]

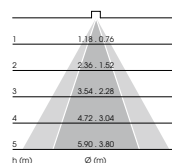

1	1.18, 0.76	1,558	2,246	3,048	3,646
2	2.36, 1.52	389	562	762	911
3	3.54, 2.28	173	250	339	405
4	4.72, 3.04	97	140	190	228
5	5.90, 3.80	62	90	122	146

For more technical details about the individual luminaires, please see our datasheets available at www.baero.com. The luminaire luminous flux figures vary in a tolerance range of ± 10%. All data are typical values. System features may change if product improvements are made due to technical advances. Errors excepted.

BeCool

Colour spectrum

BeCool is a special light colour with an LED spectrum below the Planck curve (below black body). The colour-intensified impression of the illuminated surfaces or body colours appears cool and saturated. The correlated colour temperature is 4,000 K.

REFLECTORS

WATTAGES

15W 23W 34W 41W

NARROWSPOT

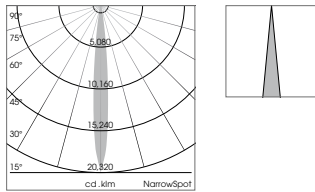

Luminaire luminous flux [lm]
Luminous efficacy [lm/W]

1,080 - - -
72 - - -

Illuminance [lx]

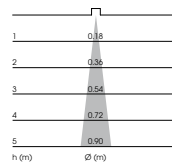

21,932 - - -
5,483 - - -
2,437 - - -
1,371 - - -
877 - - -

SPOT

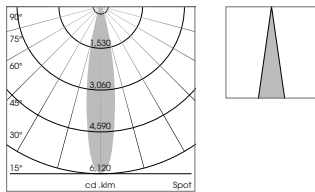

Luminaire luminous flux [lm]
Luminous efficacy [lm/W]

1,430 2,070 2,800 3,350
95 90 82 82

Illuminance [lx]

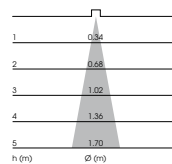

8,701 12,595 17,037 20,383
2,175 3,149 4,259 5,096
967 1,399 1,893 2,265
544 787 1,065 1,274
348 504 681 815

MEDIUM

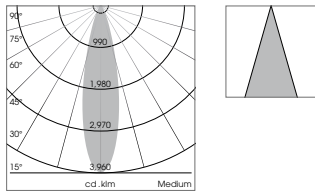

Luminaire luminous flux [lm]
Luminous efficacy [lm/W]

1,420 2,050 2,770 3,320
95 89 81 81

Illuminance [lx]

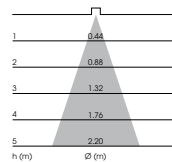

5,618 8,110 10,959 13,135
1,404 2,028 2,740 3,284
624 901 1,218 1,459
351 507 685 821
225 324 438 525

FLOOD

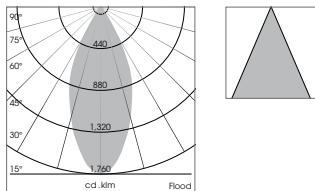

Luminaire luminous flux [lm]
Luminous efficacy [lm/W]

1,470 2,120 2,870 3,430
98 92 84 84

Illuminance [lx]

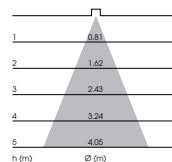

2,587 3,730 5,050 6,035
647 933 1,263 1,509
287 414 561 671
162 233 316 377
103 149 202 241

OVALBASIC

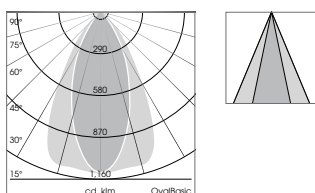

Luminaire luminous flux [lm]
Luminous efficacy [lm/W]

1,420 2,050 2,770 3,320
95 89 81 81

Illuminance [lx]

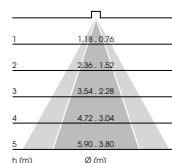

1,603 2,314 3,127 3,747
401 578 782 937
178 257 347 416
100 145 195 234
64 93 125 150

For more technical details about the individual luminaires, please see our datasheets available at www.baero.com. The luminaire luminous flux figures vary in a tolerance range of $\pm 10\%$. All data are typical values. System features may change if product improvements are made due to technical advances. Errors excepted.

BeNature

Colour spectrum

BeNature is an innovative, cross-application light color whose most similar color temperature is 3,000 K in the warm white range. With an excellent color rendering index Ra of 97, it is optimized for extremely authentic color rendering and a natural room atmosphere that promotes people's sense of well-being.

REFLECTORS

WATTAGES

15 W 23 W 34 W 41 W

NARROWSPOT

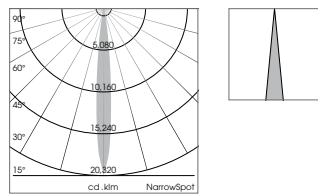

Luminaire luminous flux [lm]
Luminous efficacy [lm/W]

Illuminance [lx]

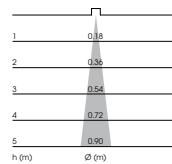

-	-	-	-
-	-	-	-
-	-	-	-
-	-	-	-
-	-	-	-
-	-	-	-

SPOT

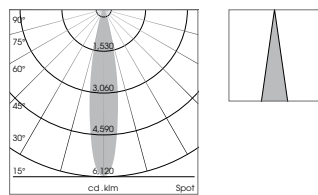

Luminaire luminous flux [lm]
Luminous efficacy [lm/W]

Illuminance [lx]

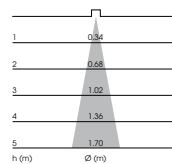

750	1,050	1,380	1,620
50	46	41	40
4,563	6,389	8,397	9,857
1,141	1,597	2,099	2,464
507	710	933	1,095
285	399	525	616
183	256	336	394

MEDIUM

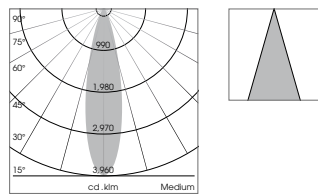

Luminaire luminous flux [lm]
Luminous efficacy [lm/W]

Illuminance [lx]

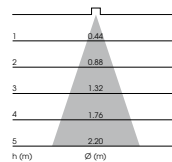

740	1,040	1,370	1,600
49	45	40	39
2,928	4,114	5,420	6,330
732	1,029	1,355	1,582
325	457	602	703
183	257	339	396
117	165	217	253

FLOOD

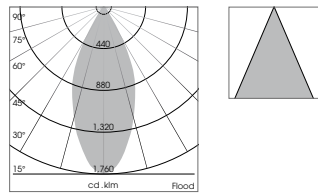

Luminaire luminous flux [lm]
Luminous efficacy [lm/W]

Illuminance [lx]

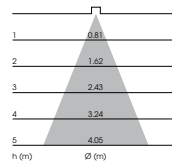

760	1,080	1,420	1,660
51	47	42	40
1,337	1,900	2,499	2,921
334	475	625	730
149	211	278	325
84	119	156	183
53	76	100	117

OVALBASIC

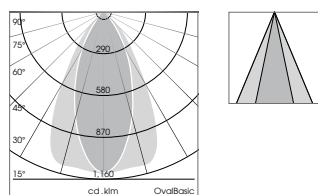

Luminaire luminous flux [lm]
Luminous efficacy [lm/W]

Illuminance [lx]

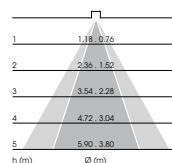

740	1,040	1,370	1,600
49	45	40	39
835	1,174	1,546	1,806
209	293	387	451
93	130	172	201
52	73	97	113
33	47	62	72

For more technical details about the individual luminaires, please see our datasheets available at www.baero.com. The luminaire luminous flux figures vary in a tolerance range of ± 10%. All data are typical values. System features may change if product improvements are made due to technical advances. Errors excepted.

GoldenBread

Colour spectrum

GoldenBread is among the product-specific LED spectrums with a correlated colour temperature of 2,500 K. In particular it produces a saturated rendering of rich golden-brown colours. The spectrum is ideal for illuminating fresh bread and bakery products.

REFLECTORS

WATTAGES

15 W

23 W

34 W

41 W

NARROWSPOT

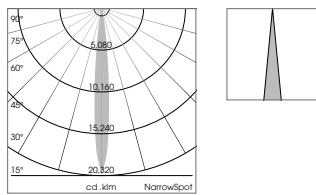

Luminaire luminous flux [lm]
Luminous efficacy [lm/W]

Illuminance [lx]

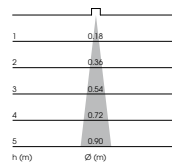

	15 W	23 W	34 W	41 W
Luminaire luminous flux [lm]	-	-	-	-
Luminous efficacy [lm/W]	-	-	-	-
Illuminance [lx]	-	-	-	-
1	-	-	-	-
2	-	-	-	-
3	-	-	-	-
4	-	-	-	-
5	-	-	-	-

SPOT

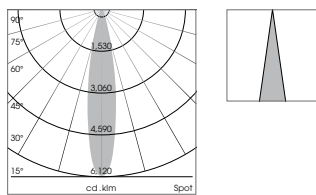

Luminaire luminous flux [lm]
Luminous efficacy [lm/W]

Illuminance [lx]

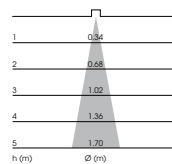

	15 W	23 W	34 W	41 W
Luminaire luminous flux [lm]	1,630	2,330	3,110	3,670
Luminous efficacy [lm/W]	109	101	91	90
Illuminance [lx]				
1	9,918	14,177	18,923	22,331
2	2,479	3,544	4,731	5,583
3	1,102	1,575	2,103	2,481
4	620	886	1,183	1,396
5	397	567	757	893

MEDIUM

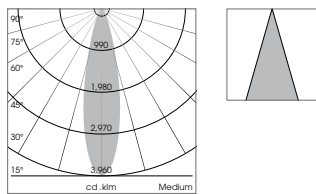

Luminaire luminous flux [lm]
Luminous efficacy [lm/W]

Illuminance [lx]

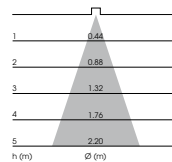

	15 W	23 W	34 W	41 W
Luminaire luminous flux [lm]	1,610	2,300	3,080	3,630
Luminous efficacy [lm/W]	107	100	91	89
Illuminance [lx]				
1	6,369	9,099	12,185	14,361
2	1,592	2,275	3,046	3,590
3	708	1,011	1,354	1,596
4	398	569	762	898
5	255	364	487	574

FLOOD

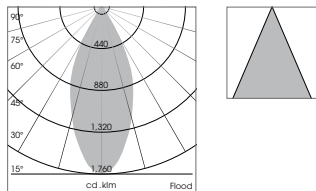

Luminaire luminous flux [lm]
Luminous efficacy [lm/W]

Illuminance [lx]

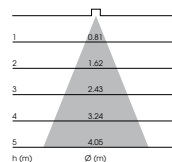

	15 W	23 W	34 W	41 W
Luminaire luminous flux [lm]	1,670	2,390	3,190	3,760
Luminous efficacy [lm/W]	111	104	94	92
Illuminance [lx]				
1	2,939	4,205	5,613	6,616
2	735	1,051	1,403	1,654
3	327	467	624	735
4	184	263	351	414
5	118	168	225	265

OVALBASIC

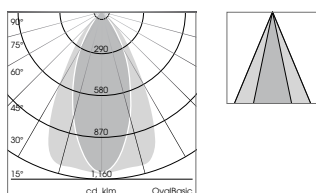

Luminaire luminous flux [lm]
Luminous efficacy [lm/W]

Illuminance [lx]

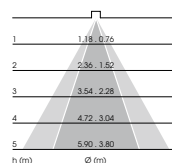

	15 W	23 W	34 W	41 W
Luminaire luminous flux [lm]	1,610	2,300	3,080	3,630
Luminous efficacy [lm/W]	107	100	91	89
Illuminance [lx]				
1	1,817	2,596	3,477	4,097
2	454	649	869	1,024
3	202	288	386	455
4	114	162	217	256
5	73	104	139	164

Sun

Colour spectrum

Sun intensifies all warm colours. The LED spectrum of the special light colour is both colour saturating and product specific, and its optimal application is the illumination of fresh fruit and vegetables or in comparable non-food sectors. The correlated colour temperature is 2,400 K.

REFLECTORS

WATTAGES

15 W 23 W 34 W 41 W

NARROWSPOT

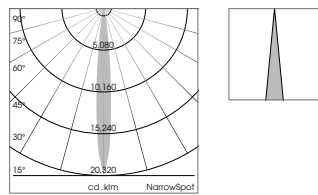

Luminaire luminous flux [lm]
Luminous efficacy [lm/W]

Illuminance [lx]

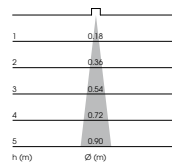

	-	-	-	-
	-	-	-	-
1	0.18	-	-	-
2	0.35	-	-	-
3	0.54	-	-	-
4	0.72	-	-	-
5	0.90	-	-	-

SPOT

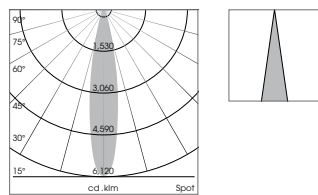

Luminaire luminous flux [lm]
Luminous efficacy [lm/W]

Illuminance [lx]

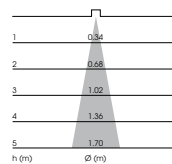

	1,080	1,540	2,040	2,390
	72	67	60	58
1	6,571	9,370	12,413	14,542
2	1,643	2,343	3,103	3,636
3	730	1,041	1,379	1,616
4	411	586	776	909
5	263	375	497	582

MEDIUM

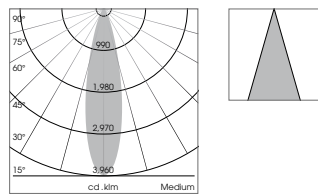

Luminaire luminous flux [lm]
Luminous efficacy [lm/W]

Illuminance [lx]

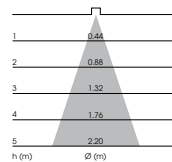

	1,070	1,520	2,010	2,360
	71	66	59	58
1	4,233	6,013	7,952	9,337
2	1,058	1,503	1,988	2,334
3	470	668	884	1,037
4	265	376	497	584
5	169	241	318	373

FLOOD

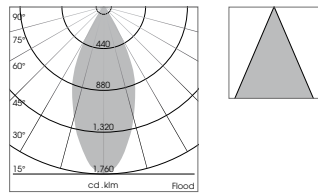

Luminaire luminous flux [lm]
Luminous efficacy [lm/W]

Illuminance [lx]

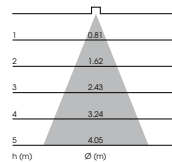

	1,110	1,580	2,090	2,440
	74	69	61	60
1	1,953	2,780	3,678	4,293
2	488	695	919	1,073
3	217	309	409	477
4	122	174	230	268
5	78	111	147	172

OVALBASIC

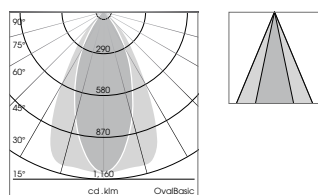

Luminaire luminous flux [lm]
Luminous efficacy [lm/W]

Illuminance [lx]

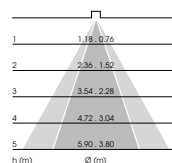

	1,070	1,520	2,010	2,360
	71	66	59	58
1	1,208	1,716	2,269	2,664
2	302	429	567	666
3	134	191	252	296
4	75	107	142	166
5	48	69	91	107

For more technical details about the individual luminaires, please see our datasheets available at www.baero.com. The luminaire luminous flux figures vary in a tolerance range of ± 10%. All data are typical values. System features may change if product improvements are made due to technical advances. Errors excepted.

Meat&Fish

Colour spectrum

Meat&Fish is among the product-specific LED spectrums with a correlated colour temperature of 4,020 K. The chromaticity point is specially coordinated to the presentation of seafood. Due to the high red component, this special light colour is also suited to the illumination of fresh meat and cold cuts.

REFLECTORS

WATTAGES

15 W

23 W

34 W

41 W

NARROWSPOT

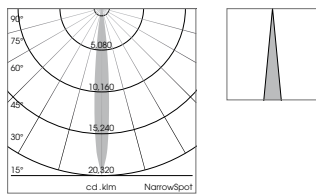

Luminaire luminous flux [lm]
Luminous efficacy [lm/W]

Illuminance [lx]

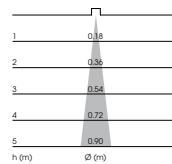

	15 W	23 W	34 W	41 W
Luminaire luminous flux [lm]	-	-	-	-
Luminous efficacy [lm/W]	-	-	-	-
Illuminance [lx]	-	-	-	-
1	0.18	-	-	-
2	0.35	-	-	-
3	0.54	-	-	-
4	0.72	-	-	-
5	0.90	-	-	-

SPOT

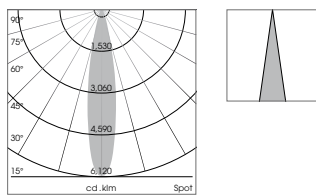

Luminaire luminous flux [lm]
Luminous efficacy [lm/W]

Illuminance [lx]

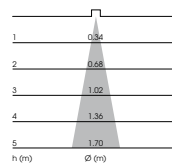

	15 W	23 W	34 W	41 W
Luminaire luminous flux [lm]	1,110	1,570	2,090	2,470
Luminous efficacy [lm/W]	74	68	61	60
Illuminance [lx]	-	-	-	-
1	0.34	6,754	9,553	12,717
2	0.68	1,688	2,388	3,179
3	1.02	750	1,061	1,413
4	1.36	422	597	795
5	1.70	270	382	509

MEDIUM

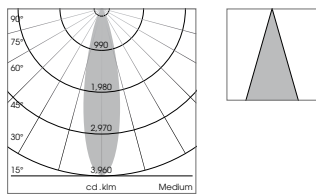

Luminaire luminous flux [lm]
Luminous efficacy [lm/W]

Illuminance [lx]

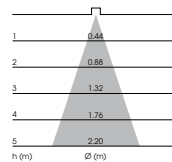

	15 W	23 W	34 W	41 W
Luminaire luminous flux [lm]	1,100	1,560	2,070	2,440
Luminous efficacy [lm/W]	73	68	61	60
Illuminance [lx]	-	-	-	-
1	0.44	4,352	6,172	8,189
2	0.88	1,088	1,543	2,047
3	1.32	484	686	910
4	1.76	272	386	512
5	2.20	174	247	328

FLOOD

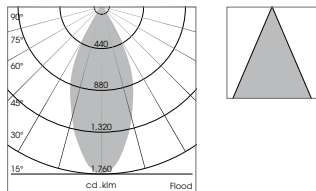

Luminaire luminous flux [lm]
Luminous efficacy [lm/W]

Illuminance [lx]

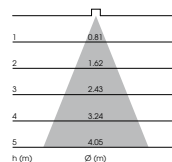

	15 W	23 W	34 W	41 W
Luminaire luminous flux [lm]	1,140	1,610	2,140	2,530
Luminous efficacy [lm/W]	76	70	63	62
Illuminance [lx]	-	-	-	-
1	0.81	2,006	2,833	3,766
2	1.62	501	708	941
3	2.43	223	315	418
4	3.24	125	177	235
5	4.05	80	113	151

OVALBASIC

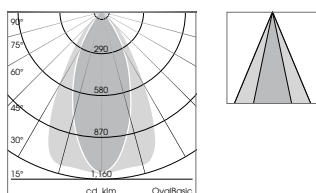

Luminaire luminous flux [lm]
Luminous efficacy [lm/W]

Illuminance [lx]

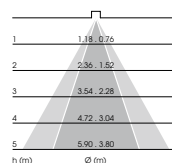

	15 W	23 W	34 W	41 W
Luminaire luminous flux [lm]	1,100	1,560	2,070	2,440
Luminous efficacy [lm/W]	73	68	61	60
Illuminance [lx]	-	-	-	-
1	1.18, 0.76	1,242	1,761	2,336
2	2.36, 1.52	310	440	584
3	3.54, 2.28	138	196	260
4	4.72, 3.04	78	110	146
5	5.90, 3.80	50	70	93

For more technical details about the individual luminaires, please see our datasheets available at www.baero.com. The luminaire luminous flux figures vary in a tolerance range of $\pm 10\%$. All data are typical values. System features may change if product improvements are made due to technical advances. Errors excepted.

SpecialMeat

Colour spectrum

SpecialMeat is the special light colour for the illumination of fresh meat and cold cuts and can be viewed as a modern LED successor to the proven SDW-T/ patented filter variant. The LED spectrum with a correlated colour temperature of 1,900 K is a product-specific special light colour.

REFLECTORS

WATTAGES

15W 23W 34W 41W

NARROWSPOT

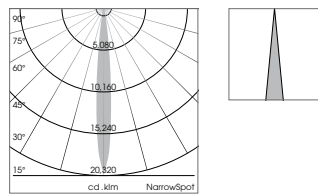

Luminaire luminous flux [lm]
Luminous efficacy [lm/W]

Illuminance [lx]

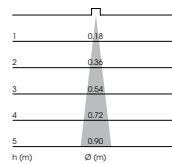

	15W	23W	34W	41W
Luminaire luminous flux [lm]	-	-	-	-
Luminous efficacy [lm/W]	-	-	-	-
Illuminance [lx]	-	-	-	-

SPOT

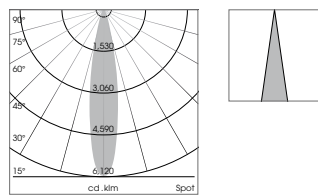

Luminaire luminous flux [lm]
Luminous efficacy [lm/W]

Illuminance [lx]

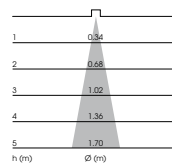

	15W	23W	34W	41W
Luminaire luminous flux [lm]	940	1,330	1,770	2,090
Luminous efficacy [lm/W]	63	58	52	51
Illuminance [lx]				

MEDIUM

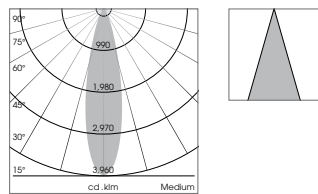

Luminaire luminous flux [lm]
Luminous efficacy [lm/W]

Illuminance [lx]

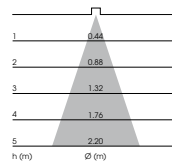

	15W	23W	34W	41W
Luminaire luminous flux [lm]	930	1,320	1,750	2,070
Luminous efficacy [lm/W]	62	57	51	50
Illuminance [lx]				

FLOOD

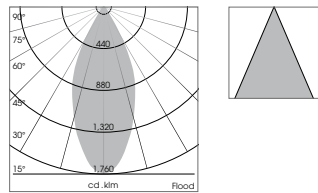

Luminaire luminous flux [lm]
Luminous efficacy [lm/W]

Illuminance [lx]

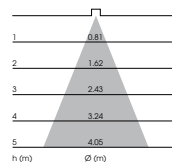

	15W	23W	34W	41W
Luminaire luminous flux [lm]	970	1,370	1,820	2,140
Luminous efficacy [lm/W]	65	60	54	52
Illuminance [lx]				

OVALBASIC

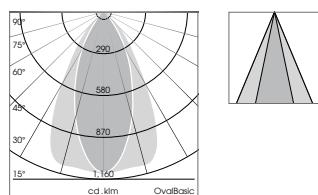

Luminaire luminous flux [lm]
Luminous efficacy [lm/W]

Illuminance [lx]

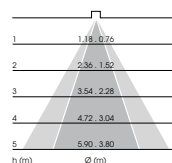

	15W	23W	34W	41W
Luminaire luminous flux [lm]	930	1,320	1,750	2,070
Luminous efficacy [lm/W]	62	57	51	50
Illuminance [lx]				

For more technical details about the individual luminaires, please see our datasheets available at www.baero.com. The luminaire luminous flux figures vary in a tolerance range of ± 10%. All data are typical values. System features may change if product improvements are made due to technical advances. Errors excepted.

Ontero IC

Surface-mounted luminaire

REFLECTOR	COL	927	830	835	840	PEARL WHITE	BECOLOR	BECOOOL	BENATURE	GOLDEN BREAD	SUN	MEAT&FISH	SPECIAL MEAT
15W													
NarrowSpot 10°	■	21430004	21430001	21430002	21430003	21430007	21430005	21430006	-	-	-	-	-
	■	21430011	21430008	21430009	21430010	21430014	21430012	21430013	-	-	-	-	-
	□	21430018	21430015	21430016	21430017	21430021	21430019	21430020	-	-	-	-	-
Spot 20°	■	21440004	21440001	21440002	21440003	21440007	21440005	21440006	21440133	21440009	21440011	21440008	21440010
	■	21440015	21440012	21440013	21440014	21440018	21440016	21440017	21440134	21440020	21440022	21440019	21440021
	□	21440026	21440023	21440024	21440025	21440029	21440027	21440028	21440135	21440031	21440033	21440030	21440032
Medium 25°	■	21450004	21450001	21450002	21450003	21450007	21450005	21450006	21447988	21450009	21450011	21450008	21450010
	■	21450015	21450012	21450013	21450014	21450018	21450016	21450017	21447989	21450020	21450022	21450019	21450021
	□	21450026	21450023	21450024	21450025	21450029	21450027	21450028	21447990	21450031	21450033	21450030	21450032
Flood 44°	■	21460004	21460001	21460002	21460003	21460007	21460005	21460006	21460133	21460009	21460011	21460008	21460010
	■	21460015	21460012	21460013	21460014	21460018	21460016	21460017	21460134	21460020	21460022	21460019	21460021
	□	21460026	21460023	21460024	21460025	21460029	21460027	21460028	21460135	21460031	21460033	21460030	21460032
OvalBasic 60°x40°	■	21470004	21470001	21470002	21470003	21470007	21470005	21470006	21467986	21470009	21470011	21470008	21470010
	■	21470015	21470012	21470013	21470014	21470018	21470016	21470017	21467987	21470020	21470022	21470019	21470021
	□	21470026	21470023	21470024	21470025	21470029	21470027	21470028	21467988	21470031	21470033	21470030	21470032
WallBeam	■	21480004	21480001	21480002	21480003	21480007	21480005	21480006	21477985	21480009	21480011	21480008	21480010
	■	21480015	21480012	21480013	21480014	21480018	21480016	21480017	21477986	21480020	21480022	21480019	21480021
	□	21480026	21480023	21480024	21480025	21480029	21480027	21480028	21477987	21480031	21480033	21480030	21480032
23W													
Spot 20°	■	21440037	21440034	21440035	21440036	21440040	21440038	21440039	21440136	21440042	21440044	21440041	21440043
	■	21440048	21440045	21440046	21440047	21440051	21440049	21440050	21440137	21440053	21440055	21440052	21440054
	□	21440059	21440056	21440057	21440058	21440062	21440060	21440061	21440138	21440064	21440066	21440063	21440065
Medium 25°	■	21450037	21450034	21450035	21450036	21450040	21450038	21450039	21450136	21450042	21450044	21450041	21450043
	■	21450048	21450045	21450046	21450047	21450051	21450049	21450050	21450137	21450053	21450055	21450052	21450054
	□	21450059	21450056	21450057	21450058	21450062	21450060	21450061	21450138	21450064	21450066	21450063	21450065
Flood 44°	■	21460037	21460034	21460035	21460036	21460040	21460038	21460039	21460136	21460042	21460044	21460041	21460043
	■	21460048	21460045	21460046	21460047	21460051	21460049	21460050	21460137	21460053	21460055	21460052	21460054
	□	21460059	21460056	21460057	21460058	21460062	21460060	21460061	21460138	21460064	21460066	21460063	21460065
OvalBasic 60°x40°	■	21470037	21470034	21470035	21470036	21470040	21470038	21470039	21470136	21470042	21470044	21470041	21470043
	■	21470048	21470045	21470046	21470047	21470051	21470049	21470050	21470137	21470053	21470055	21470052	21470054
	□	21470059	21470056	21470057	21470058	21470062	21470060	21470061	21470138	21470064	21470066	21470063	21470065
WallBeam	■	21480037	21480034	21480035	21480036	21480040	21480038	21480039	21480136	21480042	21480044	21480041	21480043
	■	21480048	21480045	21480046	21480047	21480051	21480049	21480050	21480137	21480053	21480055	21480052	21480054
	□	21480059	21480056	21480057	21480058	21480062	21480060	21480061	21480138	21480064	21480066	21480063	21480065
34W													
Spot 20°	■	21440070	21440067	21440068	21440069	21440073	21440071	21440072	21440139	21440075	21440077	21440074	21440076
	■	21440081	21440078	21440079	21440080	21440084	21440082	21440083	21440140	21440086	21440088	21440085	21440087
	□	21440092	21440089	21440090	21440091	21440095	21440093	21440094	21440141	21440097	21440099	21440096	21440098
Medium 25°	■	21450070	21450067	21450068	21450069	21450073	21450071	21450072	21450139	21450075	21450077	21450074	21450076
	■	21450081	21450078	21450079	21450080	21450084	21450082	21450083	21450140	21450086	21450088	21450085	21450087
	□	21450092	21450089	21450090	21450091	21450095	21450093	21450094	21450141	21450097	21450099	21450096	21450098
Flood 44°	■	21460070	21460067	21460068	21460069	21460073	21460071	21460072	21460139	21460075	21460077	21460074	21460076
	■	21460081	21460078	21460079	21460080	21460084	21460082	21460083	21460140	21460086	21460088	21460085	21460087
	□	21460092	21460089	21460090	21460091	21460095	21460093	21460094	21460141	21460097	21460099	21460096	21460098
OvalBasic 60°x40°	■	21470070	21470067	21470068	21470069	21470073	21470071	21470072	21470139	21470075	21470077	21470074	21470076
	■	21470081	21470078	21470079	21470080	21470084	21470082	21470083	21470140	21470086	21470088	21470085	21470087
	□	21470092	21470089	21470090	21470091	21470095	21470093	21470094	21470141	21470097	21470099	21470096	21470098
WallBeam	■	21480070	21480067	21480068	21480069	21480073	21480071	21480072	21480139	21480075	21480077	21480074	21480076
	■	21480081	21480078	21480079	21480080	21480084	21480082	21480083	21480140	21480086	21480088	21480085	21480087
	□	21480092	21480089	21480090	21480091	21480095	21480093	21480094	21480141	21480097	21480099	21480096	21480098
41W													
Spot 20°	■	21440103	21440100	21440101	21440102	21440106	21440104	21440105	21440142	21440108	21440110	21440107	21440109
	■	21440114	21440111	21440112	21440113	21440117	21440115	21440116	21440143	21440119	21440121	21440118	21440120
	□	21440125	21440122	21440123	21440124	21440128	21440126	21440127	21440144	21440130	21440132	21440129	21440131
Medium 25°	■	21450103	21450100	21450101	21450102	21450106	21450104	21450105	21450142	21450108	21450110	21450107	21450109
	■	21450114	21450111	21450112	21450113	21450117	21450115	21450116	21450143	21450119	21450121	21450118	21450120
	□	21450125	21450122	21450123	21450124	21450128	21450126	21450127	21450144	21450130	21450132	21450129	21450131
Flood 44°	■	21460103	21460100	21460101	21460102	21460106	21460104	21460105	21460142	21460108	21460110	21460107	21460109
	■	21460114	21460111	21460112	21460113	21460117	21460115	21460116	21460143	21460119	21460121	21460118	21460120
	□	21460125	21460122	21460123	21460124	21460128	21460126	21460127	21460144	21460130	21460132	21460129	21460131
OvalBasic 60°x40°	■	21470103	21470100	21470101	21470102	21470106	21470104	21470105	21470142	21470108	21470110	21470107	21470109
	■	21470114	21470111	21470112	21470113	21470117	21470115	21470116	21470143	21470119	21470121	21470118	21470120
	□	21470125	21470122	21470123	21470124	21470128	21470126	21470127	21470144	21470130	21470132	21470129	21470131
WallBeam	■	21480103	21480100	21480101	21480102	21480106	21480104	21480105	21480142	21480108	21480110	21480107	21480109
	■	21480114	21480111	21480112	21480113	21480117	21480115	21480116	21480143	21480119	21480121	21480118	21480120
	□	21480125	21480122	21480123	21480124	21480128	21480126	21480127	21480144	21480130	21480132	21480129	21480131

Contact service@baero.com for your personal price information. Please refer to our data sheets at www.baero.com for further technical details on the individual luminaires. All data are typical values. System features may change with product improvements due to technical advances. Errors excepted.

Intara IC

Semi-recessed luminaire

The separate driver unit is supplied with a feed-through wiring set. The driver unit is also available as a DALI version for integration in a light control system.

REFLECTOR	COL	927	830	835	840	PEARL WHITE	BECOLOR	BECCOOL	BENATURE	GOLDEN BREAD	SUN	MEAT&FISH	SPECIAL MEAT
15 W													
NarrowSpot 10°	■	51510004	51510001	51510002	51510003	51510019	51510005	51510006	51510022	-	-	-	-
	■	51510010	51510007	51510008	51510009	51510020	51510011	51510012	51510023	-	-	-	-
	□	51510016	51510013	51510014	51510015	51510021	51510017	51510018	51510024	-	-	-	-
15/23/34/41W													
Spot 20°	■	51520004	51520001	51520002	51520003	51520010	51520005	51520006	51520037	51520009	51520012	51520007	51520011
	■	51520016	51520013	51520014	51520015	51520022	51520017	51520018	51520038	51520021	51520024	51520019	51520023
	□	51520028	51520025	51520026	51520027	51520034	51520029	51520030	51520039	51520033	51520036	51520031	51520035
Medium 25°	■	51530004	51530001	51530002	51530003	51530010	51530005	51530006	51530037	51530009	51530012	51530007	51530011
	■	51530016	51530013	51530014	51530015	51530022	51530017	51530018	51530038	51530021	51530024	51530019	51530023
	□	51530028	51530025	51530026	51530027	51530034	51530029	51530030	51530039	51530033	51530036	51530031	51530035
Flood 44°	■	51540004	51540001	51540002	51540003	51540010	51540005	51540006	51540037	51540009	51540012	51540007	51540011
	■	51540016	51540013	51540014	51540015	51540022	51540017	51540018	51540038	51540021	51540024	51540019	51540023
	□	51540028	51540025	51540026	51540027	51540034	51540029	51540030	51540039	51540033	51540036	51540031	51540035
OvalBasic 60°x40°	■	51550004	51550001	51550002	51550003	51550010	51550005	51550006	51550037	51550009	51550012	51550007	51550011
	■	51550016	51550013	51550014	51550015	51550022	51550017	51550018	51550038	51550021	51550024	51550019	51550023
	□	51550028	51550025	51550026	51550027	51550034	51550029	51550030	51550039	51550033	51550036	51550031	51550035
WallBeam	■	51560004	51560001	51560002	51560003	51560010	51560005	51560006	51560037	51560009	51560012	51560007	51560011
	■	51560016	51560013	51560014	51560015	51560022	51560017	51560018	51560038	51560021	51560024	51560019	51560023
	□	51560028	51560025	51560026	51560027	51560034	51560029	51560030	51560039	51560033	51560036	51560031	51560035

DRIVER UNIT

On/off	76500050	[400 mA/15 Watt]
	76500034	[600 mA/23 Watt]
	76500076	[850 mA/34 Watt]
	76500037	[1,050 mA/41 Watt]
DALI	76500051	[400 mA/15 Watt]
	76500039	[600 mA/23 Watt]
	76500077	[850 mA/34 Watt]
	76500042	[1,050 mA/41 Watt]
Casambi	76500121	[400 mA/15 Watt]
	76500122	[600 mA/23 Watt]
	76500123	[850 mA/34 Watt]
	76500124	[1,050 mA/41 Watt]

The driver units must be ordered separately.

41W POTENTIOMETER

Spot 20°	■	51620004	51620001	51620002	51620003	51620010	51620005	51620006	51620037	51620009	51620012	51620007	51620011
	■	51620016	51620013	51620014	51620015	51620022	51620017	51620018	51620038	51620021	51620024	51620019	51620023
	□	51620028	51620025	51620026	51620027	51620034	51620029	51620030	51620039	51620033	51620036	51620031	51620035
Medium 25°	■	51580004	51580001	51580002	51580003	51580010	51580005	51580006	51580037	51580009	51580012	51580007	51580011
	■	51580016	51580013	51580014	51580015	51580022	51580017	51580018	51580038	51580021	51580024	51580019	51580023
	□	51580028	51580025	51580026	51580027	51580034	51580029	51580030	51580039	51580033	51580036	51580031	51580035
Flood 44°	■	51590004	51590001	51590002	51590003	51590010	51590005	51590006	51590037	51590009	51590012	51590007	51590011
	■	51590016	51590013	51590014	51590015	51590022	51590017	51590018	51590038	51590021	51590024	51590019	51590023
	□	51590028	51590025	51590026	51590027	51590034	51590029	51590030	51590039	51590033	51590036	51590031	51590035
OvalBasic 60°x40°	■	51600004	51600001	51600002	51600003	51600010	51600005	51600006	51600037	51600009	51600012	51600007	51600011
	■	51600016	51600013	51600014	51600015	51600022	51600017	51600018	51600038	51600021	51600024	51600019	51600023
	□	51600028	51600025	51600026	51600027	51600034	51600029	51600030	51600039	51600033	51600036	51600031	51600035
WallBeam	■	51610004	51610001	51610002	51610003	51610010	51610005	51610006	51610037	51610009	51610012	51610007	51610011
	■	51610016	51610013	51610014	51610015	51610022	51610017	51610018	51610038	51610021	51610024	51610019	51610023
	□	51610028	51610025	51610026	51610027	51610034	51610029	51610030	51610039	51610033	51610036	51610031	51610035

DRIVER UNIT

Potentiometer	76500109	[1,050 mA/41 Watt]
---------------	----------	--------------------

The driver units must be ordered separately.

Pendiro IC

Suspended luminaire

The variants with surface-mounted canopy and track-mounted canopy are always supplied as a DALI version. The driver unit is included in the scope of supply of the variant with recessed canopy. When placing your order please state the driver unit product number with the desired power output.

REFLECTOR	COL	927	830	835	840	PEARL WHITE	BECOLOR	BECCOOL	BENATURE	GOLDEN BREAD	SUN	MEAT&FISH	SPECIAL MEAT
NarrowSpot 10°	■	80670004	80670001	80670002	80670003	80670019	80670005	80670006	80670022	-	-	-	-
	■	80670010	80670007	80670008	80670009	80670020	80670011	80670012	80670023	-	-	-	-
	□	80670016	80670013	80670014	80670015	80670021	80670017	80670018	80670024	-	-	-	-
Spot 20°	■	80680004	80680001	80680002	80680003	80680007	80680005	80680006	80680037	80680010	80680012	80680008	80680011
	■	80680016	80680013	80680014	80680015	80680019	80680017	80680018	80680038	80680022	80680024	80680020	80680023
	□	80680028	80680025	80680026	80680027	80680031	80680029	80680030	80680039	80680034	80680036	80680032	80680035
Medium 25°	■	80690004	80690001	80690002	80690003	80690007	80690005	80690006	80690037	80690010	80690012	80690008	80690011
	■	80690016	80690013	80690014	80690015	80690019	80690017	80690018	80690038	80690022	80690024	80690020	80690023
	□	80690028	80690025	80690026	80690027	80690031	80690029	80690030	80690039	80690034	80690036	80690032	80690035
Flood 44°	■	80700004	80700001	80700002	80700003	80700007	80700005	80700006	80700037	80700010	80700012	80700008	80700011
	■	80700016	80700013	80700014	80700015	80700019	80700017	80700018	80700038	80700022	80700024	80700020	80700023
	□	80700028	80700025	80700026	80700027	80700031	80700029	80700030	80700039	80700034	80700036	80700032	80700035
OvalBasic 60°x40°	■	80710004	80710001	80710002	80710003	80710007	80710005	80710006	80710037	80710010	80710012	80710008	80710011
	■	80710016	80710013	80710014	80710015	80710019	80710017	80710018	80710038	80710022	80710024	80710020	80710023
	□	80710028	80710025	80710026	80710027	80710031	80710029	80710030	80710039	80710034	80710036	80710032	80710035

SURFACE-MOUNTED CANOPY ON / OFF

■	76500140	[400 mA/15 Watt]
■	76500142	[400 mA/15 Watt]
□	76500144	[400 mA/15 Watt]
■	76500146	[600 mA/23 Watt]
■	76500148	[600 mA/23 Watt]
□	76500150	[600 mA/23 Watt]

SURFACE-MOUNTED CANOPY DALI

■	76500062	[400 mA/15 Watt]
■	76500060	[400 mA/15 Watt]
□	76500064	[400 mA/15 Watt]
■	76500098	[600 mA/23 Watt]
■	76500096	[600 mA/23 Watt]
□	76500100	[600 mA/23 Watt]

TRACK-MOUNTED ON / OFF

■	76500139	[400 mA/15 Watt]
■	76500141	[400 mA/15 Watt]
□	76500143	[400 mA/15 Watt]
■	76500145	[600 mA/23 Watt]
■	76500147	[600 mA/23 Watt]
□	76500149	[600 mA/23 Watt]

TRACK-MOUNTED DALI

■	76500061	[400 mA/15 Watt]
■	76500059	[400 mA/15 Watt]
□	76500063	[400 mA/15 Watt]
■	76500097	[600 mA/23 Watt]
■	76500095	[600 mA/23 Watt]
□	76500099	[600 mA/23 Watt]

RECESSED CANOPY

■	76500054	for separate driver unit
■	76500053	for separate driver unit
□	76500055	for separate driver unit

DRIVER UNIT

On/Off	76500050	[400 mA/15 Watt]
	76500034	[600 mA/23 Watt]
DALI	76500051	[400 mA/15 Watt]
	76500039	[600 mA/23 Watt]
Casambi	76500121	[400 mA/15 Watt]
	76500122	[600 mA/23 Watt]

The canopies and the driver units must be ordered separately.

Accessories

for Ontero, Intara and Pendiro IC

HONEYCOMB LOUVER* 40020012
 OVALBEAM-LENS* 40020013

* Notes see page 7

Contact service@baero.com for your personal price information. Please refer to our data sheets at www.baero.com for further technical details on the individual luminaires. All data are typical values. System features may change with product improvements due to technical advances. Errors excepted.

BÄRO – Your lighting partner. Right from the start.

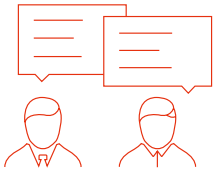

> ADVICE Discover the potential.

A fundamental aspect of our advice is to convey to all those involved in the project the huge potential and the many nuanced possibilities of expression offered by the medium light today thanks to LED technology. Talk to our lighting consultants and find out about the impact that BÄRO products can have in your store – not just in view of effectiveness and efficiency, but also and especially in terms of the emotionality of light.



> PLANNING Light that suits you.

Light can be designed in many different qualities and dimensions. Sophisticated light planning not only supports the dramaturgy of the shopping experience; it also allows the lighting to be perfectly tailored to the different visual tasks and product groups. We are committed to finding a customised, expressive light balance for every concept – through the interplay of light distribution and light channelling, light intensities and light colours.

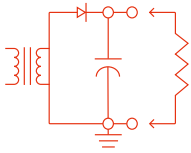

> INSTALLATION On site together.

Careful and professional installation is just as important as effective and creative lighting planning. BÄRO supports you in the installation and alignment of luminaires on site – so that your customised lighting concept rapidly takes shape and unforeseen issues are quickly resolved. In this way you can be sure that the lighting is perfectly focused on the room and the products.

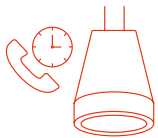

> SUPPORT Long-term cooperation.

Our products boast long-lasting quality and functionality. Nonetheless, our service does not end when your lighting system is put into operation. BÄRO is available to answer your questions and provide services even after completion of the project.



> LEASING Efficient lighting. Financed effectively.

Customised financing for a customised lighting concept. Whether you are a retailer or a retail brand, we will be pleased to advise you on a leasing concept that suits your specific needs. Together we will draw up a contract that caters to your wishes and the needs of your company. Contact us. We're pleased to assist you.

> CONTACT

Tel.: +49 800 799 1000/e-mail: service@baero.com

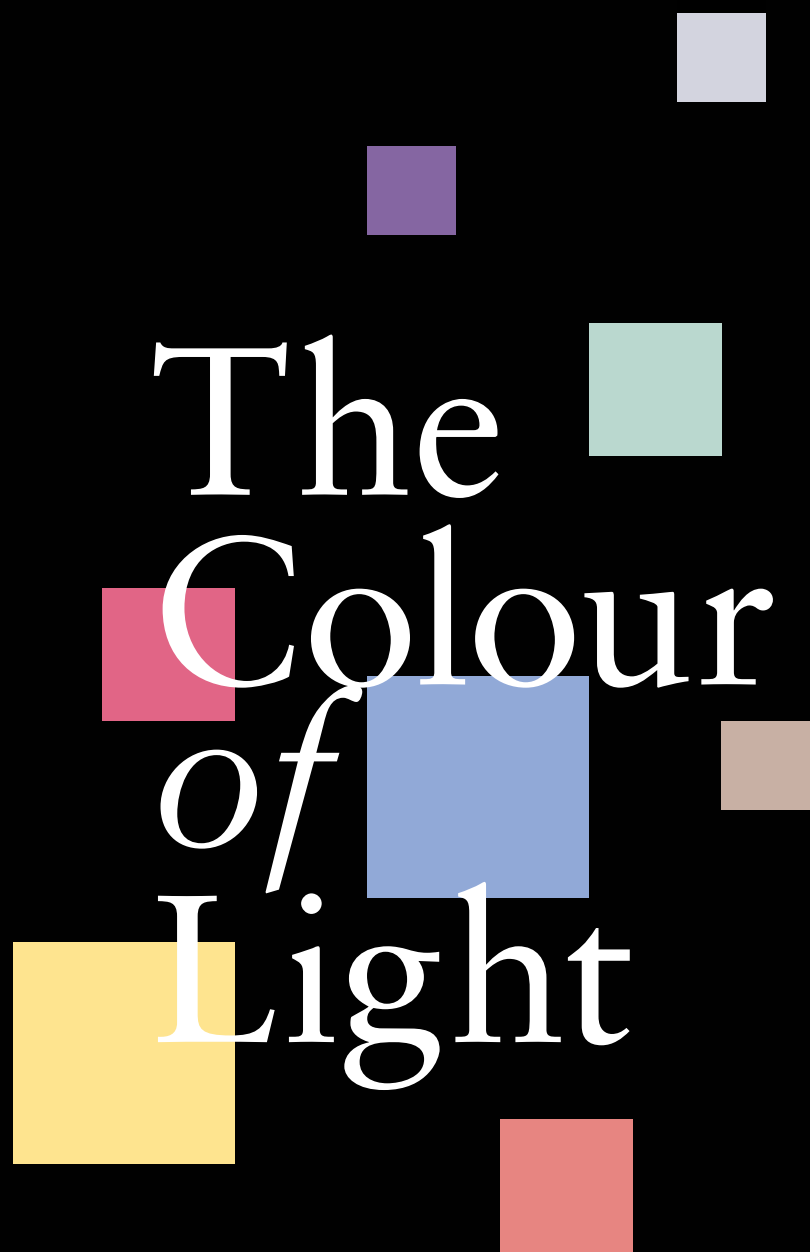

The Colour *of* Light

BÄRO GmbH & Co. KG
Wolfstall 54-56
42799 Leichlingen

T +49 2174 799 0
F +49 2174 799 799
www.baero.com